

FUJITSU

Halcyon 



Mini-Split Air Conditioners and Heat Pumps
for Residential and Light Commercial Applications



*Quietly revolutionizing
energy efficient home*



comfort.



TABLE OF CONTENTS

FEATURES

Mini-Splits Defined.....	4
Individual Zoning	6
Comfort Solution	8
Energy Efficient	9
Comfort & Convenience	10
Applications	11
Feature Descriptions	12

MODEL LINEUP

Indoor and Outdoor Model Table	14
--------------------------------------	----

SINGLE ZONE MINI-SPLITS

Wall Mount	17
Floor/Ceiling	25
Ceiling Suspended	25
Floor Mount	26
Duct	28
Compact Cassette	30
Large Cassette	32

MULTI-ZONE MINI-SPLITS

Overview	35
Indoor Units	
Wall Mount	38
Duct	39
Compact Cassette	40
Floor Mount	41
Multi-Zone (2-4 Zones) Outdoor	42
XLTH Multi-Zone (2-3 Zones) Outdoor	44
Flex-Zone (2-8 Zones) Outdoor	46
Branch Boxes	48
Piping	49
Allowable Combinations	52

ACCESSORIES

Descriptions	55
Compatibility Chart	57

MISCELLANEOUS

Line Set Length Chart	58
Model Nomenclature	58



Fujitsu Mini-Splits: Year-Round, Whole-Home or Business Energy Efficient Heating and Cooling

What is a Mini-Split?

Halcyon systems eliminate the need for a basement or attic-located evaporator unit and bulky ductwork by using thin copper tubing that pumps refrigerant directly to discreet wall mounted or concealed units inside. Even more remarkable, this same unit works in reverse in winter, absorbing heat from the outside air and moving it indoors to heat your home. The result? Efficient cooling and heating for year-round, whole-house comfort in most climates.

Available in numerous mix-and-match capacities and configurations, there's a Halcyon mini-split system for even the most difficult to heat and cool areas.

How Does a Mini-Split Work?

Like your refrigerator, heat pumps use electricity to pump refrigerant and transfer heat from one space to another. When we transfer heat from within our home to the outdoors, we call it "air conditioning". Conversely, when we transfer heat from the outdoors to within the home, we call it a "heat-pump".



Wall Mount Unit



Slim Duct Unit



Heat Pumps Provide Heat When it is Chilly

Because refrigerant is naturally much colder than outdoor temperatures even on a very cold day, it actually absorbs heat from outdoors, and transfers the heat it absorbs outside to within your home. The refrigerant's physical properties do this naturally. What you pay for is the electricity to pump refrigerant via copper tubing from outdoors to indoors. Because we move the heat rather than create it (as electric baseboard or resistant heat does), we can deliver up to 4 times the heat for the energy we consume!

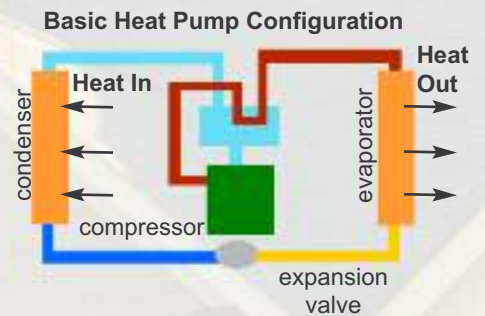

Air Conditioners Provide Cooling When It's Warm

Come spring and summer, simply reverse the process and put the same system into "cooling mode" and transfer heat from indoors to the outside. For many climates, the advanced technology that goes into these units creates a far more cost effective alternative to either gas or oil-fired units for heat, or a central ducted system for air conditioning. Fujitsu's full mini-split line up are heat pumps, which provide both heating and cooling.

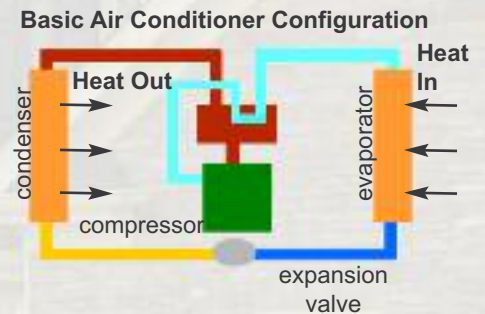

Electric Heaters versus Heat Pumps

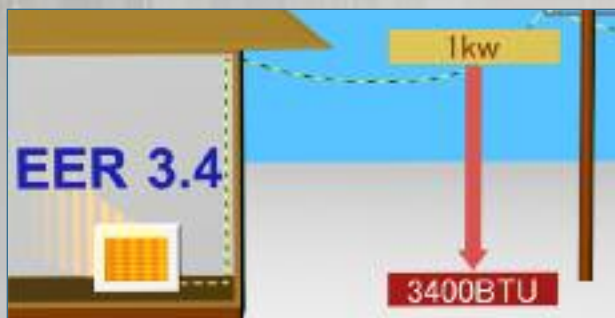

An electric heater converts electricity directly to heat, and if we assume that the heat loss is zero, the output from one kilowatt input is one kilowatt or 3,400 BTU and the EER is 3.4.

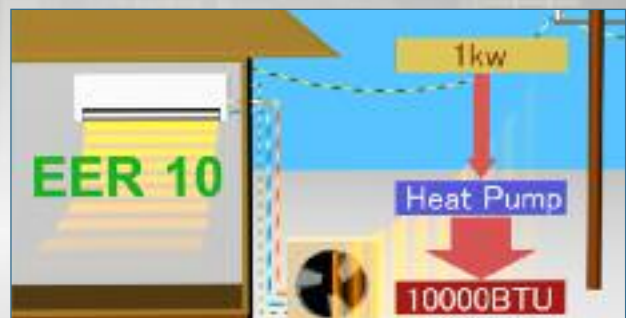

Heat pumps are more efficient than some other forms of heating because heat pumps do not actually create heat - they just move it from one place to another.

For example, the output of an efficient 10 EER heat pump is triple that of an electric heater.

*EER (Energy Efficiency Rating) = Rated BTU capacity divided by total kW input.

Individual Zoning: Personalized Whole Home Comfort

Halcyon HFI Systems are some of today's most advanced forms of heating and air conditioning. One outdoor unit can operate up to 8 indoor units simultaneously. Fujitsu's HFI Systems are super quiet as well as highly energy efficient.

- Each indoor unit can be operated independently via remote control
- Choose from a variety of indoor unit styles
- Provide both heating and cooling (not simultaneously)
- High energy efficiencies
- Quiet operation



Wall Mounted

They mount high on a wall, out of sight and do not require ductwork, increasing energy efficiency.

- Quiet operation
- Easy maintenance
- High delivered efficiency means lower utility bills

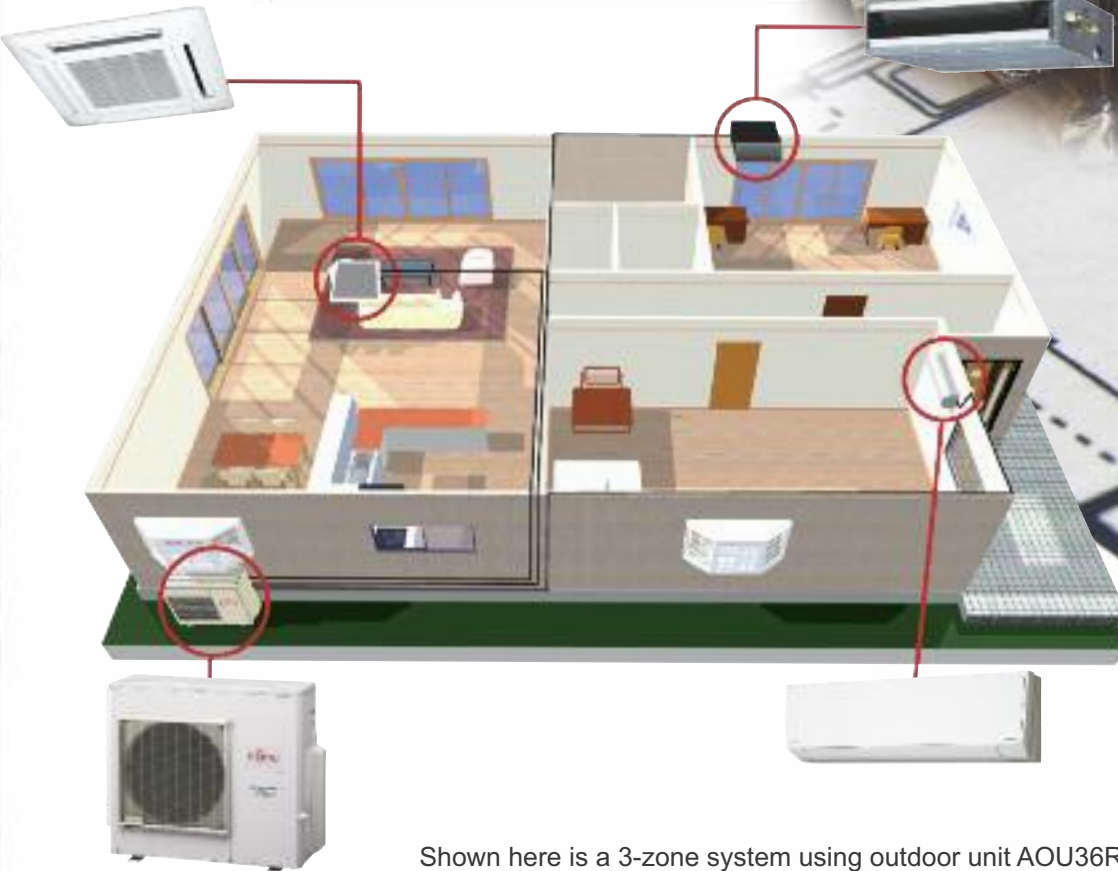

Shown here is a 3-zone system using outdoor unit AOU36RLXFZ1.



Slim Duct

Mounted in a ceiling or in a framed enclosure below a ceiling. They use minimal ductwork and remain very energy efficient.

- Concealed and out of sight
- Look of central air with the efficiency of a mini-split
- Less ducts = higher efficiency

Floor Mounted

Floor mount systems are ideal for residential radiator replacements or any room with limited upper wall space, like a kitchen or sunroom.

- Compact size fits easily under a standard window
- Features twin airflow for improved heat delivery
- Designer wireless remote control

Compact Cassette

Cassettes are extremely discreet, with only the grille showing in the ceiling. They use the latest fan technology to distribute the conditioned air evenly.

- Wired remote controller (wireless is optional)
- Powerful turbo fan operation
- Fits into a standard 2' x 2' ceiling grid

A Solution for All of Your Comfort Needs

Ductless Technology

Don't waste money cooling and heating the ducts in your walls and attic. Fujitsu systems are duct-less, meaning they install easily and won't take up valuable closet space. Since mini-splits have little to no ducting, they forego those energy losses typically associated with central forced-air systems. Duct losses in a central air system can easily account for more than 30% of energy consumption, especially if the ducts are not sealed tight or in an unconditioned space such as an attic or crawlspace.

Central Air System versus Fujitsu HFI Quad Zone

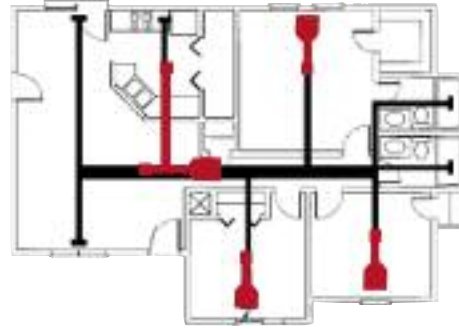

Thick black lines represent ducts of a Central Air System.

Red lines represent mini-ducts of a Fujitsu Quad Zone Slim Duct System.

Whole Home or Business Comfort

Fujitsu's Halcyon HFI systems provide home and business owners just the right amount of heating and cooling needed by installing 2 to 8 indoor units connected to one outdoor unit. Indoor units vary by size and style and each creates its own "zone" of comfort, allowing you to heat or cool individual rooms, hallways and open spaces.



A Year Round Solution

Revolutionary Halcyon heat pumps provide both heating and cooling for year round comfort in most climates. A simple push of a button on the remote control allows you to switch from heating to cooling (or vice versa) automatically.



Energy Efficient: The Smart Choice in Comfort

As much as half of the energy used in your home goes to heating and cooling. So, making smart decisions about your home's heating and air conditioning system can have a big effect on your utility bills — and your comfort.

Where Does My Money Go?



The high energy efficiencies of Halcyon systems slash utility bills by up to 24%. If your average annual utilities are \$4,200, Fujitsu can save you up to \$1,008 annually or \$10,080 in 10 yrs!*

*Savings may vary based on model selected, hours of operation and geographical location. Example given based on 33-SEER system versus 14-SEER system.

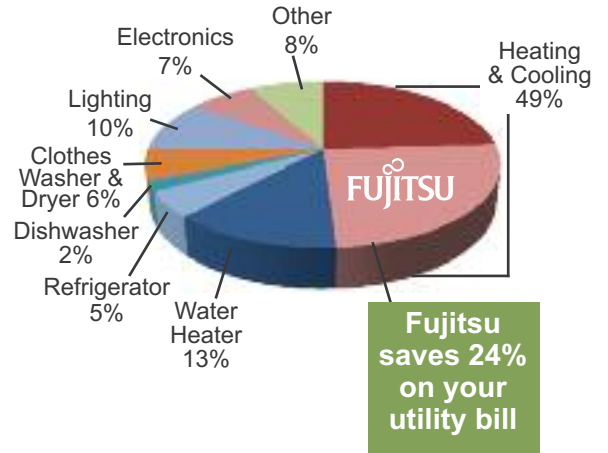

Rebates

To encourage customers to buy energy efficient products, many local utility companies offer significant rebates for the purchase of a ductless mini-split system. Go to Fujitsu's web site to search for local rebates, consumer loans and utility bill discounts. We provide a listing of rebates and offerings on qualifying Fujitsu mini-splits by zip code. www.fujitsugeneral.com



ENERGY STAR® Qualified Systems

If your HVAC equipment is more than 10 years old or not keeping your house comfortable, you should have it looked at by a professional HVAC contractor. If it is not performing efficiently or needs upgrading, consider replacing it with a unit that has earned ENERGY STAR®. Installed correctly, these high-efficiency heating and cooling units can save up to 25 percent on heating and cooling costs.

Fujitsu has 33 systems that are ENERGY STAR qualified in 2016. See the lineup chart on pages 14 - 15 for a full listing of all ENERGY STAR® qualified systems.



SEER ≥ 15.0 EER ≥ 12.5 HSPF ≥ 8.5

Comfort and Convenience

Flexible and Quiet

Mini splits offer flexibility because they can be suspended from a ceiling, mounted flush behind a drop ceiling, hung on a wall or floor-standing. Ductless heat pumps allow for a peaceful inside environment by enabling the contractor to install components like compressors and motors outdoors.

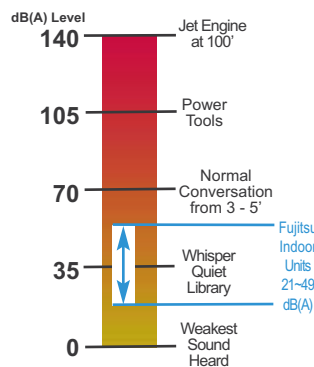

Constant Comfort through Inverter Technology

Inverter technology is like cruise control for your heating or cooling system. Compressors only run as fast as they need to handle the cooling or heating demand. They can handle greater extremes in temperature, are smoother and more stable in operation, and reach the desired temperature more quickly than conventional air conditioners.

Inverter Benefits

- More heat at lower outdoor temperatures
- Lower RPMs = quieter operation
- Desired temperature in half the time
- Up to 30% more efficient
- Stable temperature

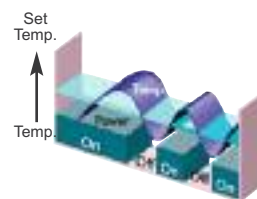

Conventional System

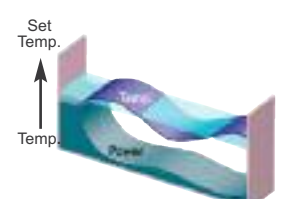

Inverter System

User Friendly Control

Fujitsu is using ergonomics to expand the use of user friendly designs such as easy-to-read large LCD displays, easy-to-operate buttons, and displays with easily recognizable colors and icons. We are producing control systems that provide greater convenience for both individual and centralized control with operability suitable for the application.



Optional Wired Remote UTY-RVNUM

Standard Wireless Remote for select systems



Applications



Where can mini-splits be used?

- Convenience stores
- Fast food chains
- Fire houses
- Police stations
- Oil rigs
- Bars
- Sunrooms and additions
- Warehouses
- Nursing homes
- Small offices
- Older homes
- New construction homes
- Schools
- Places of worship
- Hospitals and medical facilities
- Restaurants
- Computer rooms
- Hotels and motels
- Car washes
- ATM vestibules

Just about any place that requires comfort!



Feature Explanation

SEER

Seasonal Energy Efficiency Rating. Used to express efficiency of an AC or Heat Pump. A higher rating means more efficient.

HSPF

Heating Seasonal Performance Factor, measures the efficiency of heating portion of your heat pump.



ENERGY STAR® Qualified

Qualified products and practices help you save money and reduce greenhouse gas emissions by meeting strict energy efficiency guidelines set by the U.S. Environmental Protection Agency and the U.S. Department of Energy.



Apple Catechin Filter (polyphenol ingredient from apples)

Dust, mold spores and microorganisms are absorbed onto the filter by static electricity and growth is inhibited and deactivated. 3 - 12 month life expectancy, depending on environment.



Ion Deodorizing Filter

Deodorizes by decomposing absorbed odors using the oxidizing and reducing effects of ions generated by fine ceramic particles. 3 year life expectancy. Wash to restore surface action.



Sleep Timer

Automatically adjusts the temperature while you sleep to make you more comfortable.



24 Hour Timer

Allows for one on/off cycle during a 24 hour period.



Weekly Timer

Allows you to set on/off time twice a day and a different on/off time by day.



Dry Mode

Allows for moisture removal in low load conditions of up to 50% of rated moisture removal capacity.



Auto Louver: Up/Down

Redirects airflow automatically with seven position up and down motion which can be set to auto swing.



Auto Louver: 4 Way

Redirects airflow automatically with up/down and left/right motion.



Auto Fan Mode

System starts in high fan speed and automatically adjusts downward as room begins to reach set temperature.



Powerful Operation

20 minutes of continuous operation at maximum airflow and maximum compressor speed. Rapid cooling and heating makes the room comfortable quickly.



Minimum Heat Mode

Sets room temperature to 50°F, keeping temperatures above freezing and reducing power consumption.



Economy Mode

Thermostat setting automatically changes according to the temperature to avoid unnecessary cooling and heating.



Energy Saver

Keeps room cool enough for comfort by using a relaxed thermostat setting reducing power consumption.



Energy Saving Program (ESP)

If a space is left without turning the unit off, ESP knows that it is unoccupied and 20 minutes later, temperature is adjusted accordingly until users return to the room. Function is disable in multi-zone installations.



Quiet Mode (Indoor Unit)

An extra quiet fan speed to make sure you are not disturbed.



Outdoor Unit Low Noise

Limits compressor and fan speed during high speed operation for a 3 dB noise reduction.*



Power Diffuser

An additional louver that opens based on monitoring sensors to quickly enhance immediate comfort needs.



Auto Restart/Reset

Following a power failure, systems will automatically restart in the same operating mode as before, once power has been restored.



Auto Changeover (heating to cooling or vice-versa)

Automatically alternates between heating or cooling if the room temperature falls 4°F below the set temperature when cooling or rises 4°F above set temperature when heating.*



Low Ambient Cooling

Can operate in cooling mode even when outdoor ambient is 0°F, 14°F or 32°F, depending on model, without modification. Operation outside of factory specification is not recommended.



Blue Fin Heat Exchanger

Blue fin treatment to the outdoor unit's heat exchanger improves corrosion resistance.



Expanded Heating Performance

Delivers 100% of rated heating capacity at 5°F (-15°C) and operates down to -5°F (-21°C).



Cold Prevention

Indoor coil will warm prior to fan operating, preventing cold air during heating mode.



Slender Fit

Cassette body can be moved downward into the room 1-3/8" to accommodate limited ceiling space.



Remote Temperature Sensor

Room temperature sensor is located in optional wired remote controller only.



Pump Down Operation

Collects all refrigerant in system back into the outdoor unit when the unit is to be moved or before servicing the refrigerant circuit.



Daisy Chain

Ability to connect up to 16 identical style indoor units to one wired remote.



High Ceiling Mode

Temperature at the top of a high ceiling room may be warmer than the space occupied; this mode adjusts for this difference.



Branch Duct Capable

Systems are capable of attaching field-supplied branch ducts providing up to 38% of the cooling up to 16 feet away.



Fresh Air Intake

Outside air can be introduced by attaching field supplied flexible duct to fresh air knockouts.



Base Pan Heater

Prevents condensate from freezing on the outdoor unit.



Third Party Device Control

Turns system on or off using a normally closed circuit. Interface with third party devices such as home automation.



Warranty

Fujitsu systems come with either a 2 Year Parts / 6 Year Compressor warranty or up to a 12 Year Parts / Compressor warranty¹.



Warranty

*Auto Changeover is not designed to provide rapid changes between heating and cooling operation or simultaneous heating and cooling. This feature is not recommended for systems with more than one indoor unit unless all indoor units have similar heating and cooling requirements and have similar temperature set points. If all indoor units have similar heating and cooling requirements and have similar temperature set points, auto changeover will work.

+Function is bypassed during defrost and at low speed operation. This feature may limit cooling/heating capacity during high/low ambient conditions and increase energy consumption as system may need to operate longer due to reduced compressor speed.

¹ Applies when properly registered AND installed by a Fujitsu Elite Contractor in a residence. See full warranty for details.

Feature Summary





	Single Zone Wall Mount Heat Pumps	Single Zone Ducted	Single Zone Cassette	Universal/Ceiling Susp.	Floor Mount	Large Cassette	HFI Multi-Zone and Flex-Zone
	9RL2 9RLFW1 9RLS3 9RLS3H 12RL2 12RLFW1 12RLS3 12RLS3H 15RLS3 15RLS3H 18RLB 18RLXFW1 18RLXFWH 24RLB 24RLXFW1 24RLXFWH 30RLXEH 30RLXB 36RLXB	9RL2 9RLFW1 9RLS3 9RLS3H 12RL2 12RLFW1 12RLS3 12RLS3H 15RLS3 15RLS3H 18RLB 18RLXFW1 18RLXFWH 24RLB 24RLXFW1 24RLXFWH 30RLXEH 30RLXB 36RLXB	9RL2 9RLFW1 9RLS3 9RLS3H 12RL2 12RLFW1 12RLS3 12RLS3H 15RLS3 15RLS3H 18RLB 18RLXFW1 18RLXFWH 24RLB 24RLXFW1 24RLXFWH 30RLXEH 30RLXB 36RLXB	9RL2 9RLFW1 9RLS3 9RLS3H 12RL2 12RLFW1 12RLS3 12RLS3H 15RLS3 15RLS3H 18RLB 18RLXFW1 18RLXFWH 24RLB 24RLXFW1 24RLXFWH 30RLXEH 30RLXB 36RLXB	9RL2 9RLFW1 9RLS3 9RLS3H 12RL2 12RLFW1 12RLS3 12RLS3H 15RLS3 15RLS3H 18RLB 18RLXFW1 18RLXFWH 24RLB 24RLXFW1 24RLXFWH 30RLXEH 30RLXB 36RLXB	9RL2 9RLFW1 9RLS3 9RLS3H 12RL2 12RLFW1 12RLS3 12RLS3H 15RLS3 15RLS3H 18RLB 18RLXFW1 18RLXFWH 24RLB 24RLXFW1 24RLXFWH 30RLXEH 30RLXB 36RLXB	HFI: Small Wall (RLF1: 7, 9, 12k BTU) HFI: Designer Wall ¹ (RLS2: 9, 12, 15k BTU) HFI: Large Wall (16, 24k BTU) HFI: Cassette HFI: Slim Duct HFI: Floor Mount
SEER	9.0 16.0	11.0 23.0	14.2 33.0	14.0 33.0	9.0 16.0	11.0 22.0	13.8 29.3
HSPF	9.0 16.0	11.0 23.0	14.2 33.0	14.0 33.0	9.0 16.0	11.0 22.0	13.8 29.3
ENERGY STAR [®] Qualified	●	●	●	●	●	●	●
Apple Catechin Filter	●	●	●	●	●	●	●
Ion Deodorizing Filter	●	●	●	●	●	●	●
Sleep Timer	●	●	●	●	●	●	●
24 Hour Timer	●	●	●	●	●	●	●
Weekly Timer	□	●	●	●	●	●	●
Dry Mode	●	●	●	●	●	●	●
Auto Louver: Up/ Down	●	●	●	●	●	●	●
Auto Louver: 4 Way	●	●	●	●	●	●	●
Auto Fan Mode	●	●	●	●	●	●	●
Powerful Operation	●	●	●	●	●	●	●
Minimum Heat Mode	●	●	●	●	●	●	●
Economy Mode	●	●	●	●	●	●	●
Energy Saver	●	●	●	●	●	●	●
Energy Saving Program	●	●	●	●	●	●	●
Quiet Mode (Indoor Unit)	●	●	●	●	●	●	●
Outdoor Unit Low Noise	●	●	●	●	●	●	●
Power Diffuser	●	●	●	●	●	●	●
Auto Restart/Reset	●	●	●	●	●	●	●
Auto Changeover	●	●	●	●	●	●	●
Low Ambient Cooling	●	●	●	●	●	●	●
0-Degree Ambient Cooling	●	●	●	●	●	●	●
Blue Fin Heat Exchanger	●	●	●	●	●	●	●
Expanded Heating Performance	●	●	●	●	●	●	●
Long Piping Length (165'+)	●	●	●	●	●	●	●
Cold Prevention	●	●	●	●	●	●	●
Slender Fit	●	●	●	●	●	●	●
Remote Temperature Sensor	□	□	□	□	□	□	□
Daisy Chain	□	□	□	□	□	□	□
Pump Down Operation	●	●	●	●	●	●	●
High Ceiling Mode	●	●	●	●	●	●	●
Branch Duct Capable	●	●	●	●	●	●	●
Condensate Pump	●	●	●	●	●	●	●
Fresh Air Intake	●	●	●	●	●	●	●
Base Pan Heater	●	●	●	●	●	●	●
Third Party Device Control**	○	○	○	○	○	○	○
Warranty: 6 Yr Compressor / 2 Yr Parts	●	●	●	●	●	●	●
Warranty: 12 Yr Compressor / Parts ¹	●	●	●	●	●	●	●



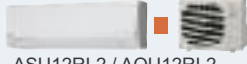
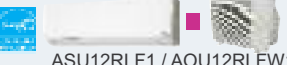
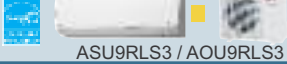
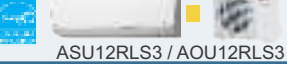
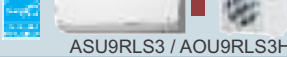



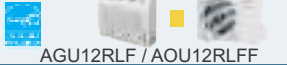

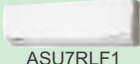
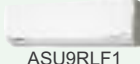
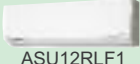
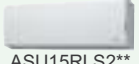
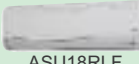

¹ SEER and HSPF ratings depend on combination of indoor units and outdoor unit selected.
 □ Available only with optional wired remote controller. □* Available only with optional wired remote controller and optional Interface Kit.
 ● Available only with optional wireless remote controller. ○ Available only with optional Interface Kit.
 ♦ Available only with optional Fresh Air Intake Kit. * Available only when used with Flex Zone AOU48RLXFZ1 outdoor unit.
 * See bottom of Page 15 for qualifying combinations. ** Operation monitoring and On/Off control only.
 + Auto Changeover is not designed to provide rapid changes between heating and cooling operation or simultaneous heating and cooling. This feature is not recommended for systems with more than one indoor unit unless all indoor units have similar heating and cooling requirements and have similar temperature set points. If all indoor units have similar heating and cooling requirements and have similar temperature set points, auto changeover will work.
¹ Blue Fin is featured on outdoor multi-zone models AOU18RLXFZ, AOU18RLXFZH, AOU24RLXFZ, AOU24RLXFZH, AOU36RLXFZ1, and AOU48RLXFZ1.
¹ ASU15RLS2 is NOT compatible with AOU18/24/36RLXFZH, AOU36RLXFZ1, or AOU45RLXFZ.

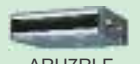
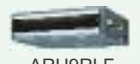
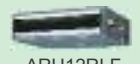
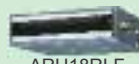
Single Zone And Multi-Zone Systems Lineup

Minimum Ambient Heating Temperatures: ■ +14°F ■ +5°F ■ 0°F ■ -5°F ■ -15°F











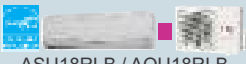

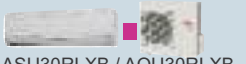
SINGLE ZONE WALL MOUNTED MINI-SPLITS				
BTU	9,000	12,000	15,000	
Wall Mount Entry Level Heat Pump	 ASU9RL2 / AOU9RL2	 ASU12RL2 / AOU12RL2		
Wall Mount High SEER	 ASU9RLF1 / AOU9RLF1	 ASU12RLF1 / AOU12RLF1		
Wall Mount Highest Efficiency	 ASU9RLS3 / AOU9RLS3	 ASU12RLS3 / AOU12RLS3	 ASU15RLS3 / AOU15RLS3	
Wall Mount Extra Low Temp Heating	 ASU9RLS3 / AOU9RLS3H	 ASU12RLS3 / AOU12RLS3H	 ASU15RLS3 / AOU15RLS3H	

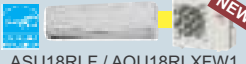
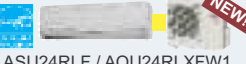
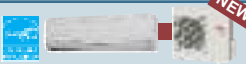
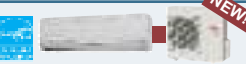
SINGLE ZONE NON-WALL MOUNTED MINI-SPLITS				
Universal Mount Floor/Ceiling				
Ceiling Suspended				
Large Cassette				
Slim Duct Horizontal/Vertical	 ARU9RLF / AOU9RLFC	 ARU12RLF / AOU12RLFC		
Compact Cassette	 AAU9RLF / AOU9RLFC	 AAU12RLF / AOU12RLFC		
Floor Mount Highest Efficiency	 AGU9RLF / AOU9RLFF	 AGU12RLF / AOU12RLFF	 AGU15RLF / AOU15RLFF	
Floor Mount Extra Low Temp Heating	 AGU9RLF / AOU9RLFFH	 AGU12RLF / AOU12RLFFH	 AGU15RLF / AOU15RLFFH	

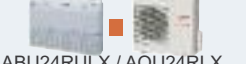
MULTI ZONE MINI-SPLITS - INDOOR UNITS						
BTU	7,000	9,000	12,000	15,000	18,000	24,000
Compact Wall Mount	 ASU7RLF1	 ASU9RLF1	 ASU12RLF1	 ASU15RLS2**		
Large Wall Mount					 ASU18RLF	 ASU24RLF
Slim Duct	 ARU7RLF	 ARU9RLF	 ARU12RLF		 ARU18RLF	 ARU24RLF
Compact Cassette	 AAU7RLF	 AAU9RLF	 AAU12RLF		 AAU18RLF	
Floor Mount		 AGU9RLF	 AGU12RLF	 AGU15RLF		

** ASU15RLS2 is NOT compatible with AOU18/24/36RLXFZH, AOU36RLXFZ1 or AOU45RLXFZ.

Minimum Ambient Heating Temperatures: ■ +14°F ■ +5°F ■ 0°F ■ -5°F ■ -15°F

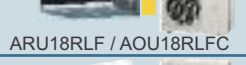
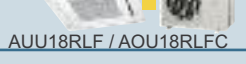
	18,000	24,000	30,000	36,000	42,000
	 ASU18RLB / AOU18RLB	 ASU24RLB / AOU24RLB	 ASU30RLXB / AOU30RLXB	 ASU36RLXB / AOU36RLXB	
	 NEW! ASU18RLF / AOU18RLXFW1	 NEW! ASU24RLF / AOU24RLXFW1			
	 NEW! ASU18RLF / AOU18RLXFWH	 NEW! ASU24RLF / AOU24RLXFWH	 NEW! ASU30RLE / AOU30RLXEH		
	 ABU18RULX / AOU18RLX	 ABU24RULX / AOU24RLX			
				 ABU36RSLX / AOU36RLX	
	 AUU18RCLX / AOU18RLX	 AUU24RCLX / AOU24RLX		 AUU36RCLX / AOU36RLX	 AUU42RCLX / AOU42RLX
	 ARU18RLF / AOU18RLFC				
	 AAU18RLF / AOU18RLFC				

MULTI ZONE MINI-SPLITS - OUTDOOR UNITS

BTU	18,000 (2 Indoor Units)	24,000 (2 - 3 Indoor Units)	36,000 (2* - 4 Indoor Units)	45,000 (2 - 5 Indoor Units)	48,000 (2 - 8 Indoor Units)
	 AOU18RLXFZ	 AOU24RLXFZ	 AOU36RLXFZ1	 NEW! AOU45RLXFZ	 AOU48RLXFZ1
	 AOU18RLXFZH	 AOU24RLXFZH	 NEW! AOU36RLXFZH		

* If AOU36RLXFZ1 is paired with two 18,000 BTU indoor units, you have to purchase optional kit Part #K9FZ1818.

† The only combinations that qualify for ENERGY STAR® are:

- AOU18RLXFZ with (2) ASU9RLF1
- AOU18RLXFZ with (1) ASU7RLF1 + (1) ASU12RLF1
- AOU18RLXFZ with (1) ASU9RLF1 + (1) ASU12RLF1
- AOU18RLXFZH with (2) ASU9RLF1
- AOU24RLXFZ with (2) ASU7RLF1 + (1) ASU9RLF1
- AOU24RLXFZH with (2) ASU7RLF1 + (1) ASU9RLF1
- AOU36RLXFZ1 with (4) ASU9RLF1
- AOU36RLXFZH with (4) ASU9RLF1

SINGLE ZONE MINI-SPLIT SYSTEMS

*Making the hottest places
cool and the coolest places
more comfortable*

- Extensive lineup from 9,000 to 42,000 BTU/h
- 39 different systems available in 11 indoor unit styles
- Energy efficient systems with SEER ratings as high as 33.0 and HSPF as high as 14.2
- 25 ENERGY STAR® qualified systems
- Inverter Technology is used in all systems
- All systems feature environmentally friendly R410A refrigerant
- Quiet operation with indoor units as low as 21 dB and outdoor units as low as 47 dB



Wall Mounted 115V Inverter 9, and 12,000 BTU Systems

SYSTEMS 9RL2, 12RL2



16.0 SEER

Function

Stylish, slim and elegant, these popular wall mounted units are designed for single rooms. Indoor units have a clean, aesthetic design and are small but mighty and shorter in length than competing units, helping them blend into any room. These 16-SEER heat pump systems now feature Inverter technology, environmentally friendly R410A refrigerant, both heating and cooling operation, quiet mode and easy maintenance.

Applications

This category of equipment is ideal for smaller spaces where spot cooling or heating is required. Residential applications including sunrooms and additions are made easier with these 115 volt heat pumps. Do you have a warm or cool spot in your home? Fujitsu mini-splits can provide extra cooling or heating capacity for those hard to cool areas. Commercially, their small size makes them ideal for small offices, providing individual temperature control.

Easy Maintenance

Front panel is easily removed for cleaning.



Standard Features

- Wireless Remote Control
- Sleep Timer
- Dry Mode
- Auto Louver
- Auto Mode
- Powerful Operation
- Quiet Mode
- Economy Mode
- Auto Restart/Reset
- Auto Changeover
- Low Ambient
- Cold Prevention



*Applies when properly registered AND installed by a Fujitsu Elite Contractor in a residence. See full warranty for details.

	9RL2 Heat Pump	12RL2 Heat Pump
Nominal Cooling BTU/h	9,000	12,000
Min.-Max. Cooling BTU/h	1,700~10,700	3,100~12,500
Nominal Heating BTU/h	10,000	14,000
Min.-Max. Heating BTU/h	1,700~12,000	3,100~16,000
HSPF BTU/hW	9.0	9.0
SEER BTU/hW	16.0	16.0
EER Clg	10.8	10.0
Clg. Operating Range °F(°C)	15~115 (-10~46)	15~115 (-10~46)
Htg. Operating Range °F(°C)	15~75 (-10~24)	15~75 (-10~24)
Moisture Removal Pt./h(l/h)	2.7 (1.3)	3.8 (1.8)
Voltage/Frequency/Phase	115/60/1	115/60/1
MAX.CRT.BKR (A)	15	20
Air Circ. C.F.M. (m ³ /h): Hi	436 (740)	436 (740)
Medium	353 (600)	353 (600)
Low	265 (450)	265 (450)
Quiet	191 (325)	191 (325)
Noise Level dB(A) Clg/Htg: Hi	43/43	43/43
Medium	38/38	38/38
Low	33/33	33/33
Quiet	23/23	23/23
Outdoor Noise Level dB(A) Clg/Htg	47/48	51/51
Current (A): Cooling	7.5	10.9
Heating	7.0	11.0
Power Use (kw): Cooling	0.83	1.20
Heating	0.77	1.21
Fan Speeds Stage	4 + Auto	4 + Auto
Air Direction: Horizontal	Manual	Manual
Vertical	Automatic	Automatic
Air Filter	Washable	Washable
Connection Method	Flare	Flare
Combined Min. Lgth Ft (m)	10 (3)	10 (3)
Combined Max. Lgth Ft (m)	66 (20) (pre-charge: 49')	66 (20) (pre-charge: 49')
Max. Vertical Diff. Ft (m)	49 (15)	49 (15)
Conn. Pipe Diameter Inch	Suc. 3/8 Dis. 1/4	Suc. 3/8 Dis. 1/4
Net Weight lbs. (kg)	16 (7) 64 (29)	16 (7) 69 (31)
Dimensions: Height Inch	10-5/16	21-1/4 10-5/16
mm	262	540 262 540
Width Inch	32-9/32	26 32-9/32
mm	820	660 820 660
Depth Inch	8-1/8	11-11/32 8-1/8
mm	206	290 206 290
Refrigerant	R410A	R410A
Indoor ASU9RL2		Indoor ASU12RL2
Outdoor AOU9RL2		Outdoor AOU12RL2

Note: Figures are based on 115 Volts.

Wall Mounted High-SEER 9, 12 and 15,000 BTU Systems

SYSTEMS 9RLS3, 12RLS3, 15RLS3



Up to 33.0 SEER

ESP Energy Saving Program

These Halcyon systems know how to save you money even when you forget. If you leave the room without turning the unit off, ESP knows that you left and 20 minutes later, set temperature is increased by 4°F when cooling and reduced by 8°F when heating. When you come back to the room, it returns to previous operating mode. This prevents wasteful operation to save energy without you having to think about it. This feature can be deactivated if chosen.



High Performance Heating

Heating capacity at low outdoor temperatures was improved by adopting a large heat exchanger and a high capacity compressor. Rated heating capacity is maintained down to 20°F. This new model can operate down to -5°F.

Standard Features for RLS3 and RLS3H Models

- Wireless Remote Control
- Energy Saving Program
- Apple Catechin Filter
- Economy Mode
- Ion Deodorizing Filter
- Quiet Mode (Indoor)
- Sleep Timer
- Low Noise Mode
- 24 Hour Timer
- Auto Restart/Reset
- Weekly Timer
- Auto Changeover
- Dry Mode
- Low Ambient Cooling
- Auto Louver: 4-Way
- Cold Prevention
- Auto Mode
- Remote Temp. Sensor*
- Powerful Operation Mode
- 3rd Party Device Control*
- Minimum Heat Mode

* Available only with optional wired remote controller and optional interface kit.
 + Available only with optional interface kit. Operation monitoring and On/Off control only.

Optional Accessories

- Wired Remote Controller: UTY-RVNUM
Backlit and includes room temperature
- Wired Remote Controller: UTY-RNNUM
- Simple Remote Controller: UTY-RSNUM
- Communication Kit: UTY-TWBXF1
- Dry Contact Wire Kit: UTY-XWZXZ5



*Applies when properly registered AND installed by a Fujitsu Elite Contractor in a residence. See full warranty for details.

	9RLS3 Heat Pump	12RLS3 Heat Pump	15RLS3 Heat Pump
Nominal Cooling BTU/h	9,000	12,000	14,500
Min.~Max. Cooling BTU/h	3,100~12,000	3,100~13,600	3,100~18,400
Nominal Heating BTU/h	12,000	16,000	18,000
Min.~Max. Heating BTU/h	3,100~22,000	3,100~22,100	3,100~23,900
HSPF BTU/hW	14.2	14.0	13.4
SEER BTU/hW	33.0	29.3	25.3
EER Clg	18.0	15.2	13.9
Clg. Operating Range °F(°C)	14~115 (-10~46)	14~115 (-10~46)	14~115 (-10~46)
Htg. Operating Range °F(°C)	-5~75 (-21~24)	-5~75 (-21~24)	-5~75 (-21~24)
Moisture Removal Pt./h(l/h)	2.6 (1.2)	2.7 (1.3)	4.0 (1.9)
Voltage/Frequency/Phase	208-230/60/1	208-230/60/1	208-230/60/1
MAX.CRT.BKR (A)	15	15	20
Air Circ. C.F.M. (m³/h): Hi	489 (830)	489 (830)	547 (930)
Medium	400 (680)	400 (680)	459 (780)
Low	341 (580)	341 (580)	371 (630)
Quiet	224 (380)	224 (380)	Clg 259 (440) Htg 294 (500)
Noise Level dB(A) Clg/Htg: Hi	42/41	42/41	45/45
Medium	37/35	37/35	40/39
Low	32/31	32/31	34/33
Quiet	23/23	23/23	26/27
Outdoor Noise Level dB(A) Clg/Htg	42/47	43/47	49/50
Current Rated/Max (A): Cooling	2.5/9.4	3.8/9.4	4.8/9.9
Heating	3.3/10.0	4.7/11.9	5.2/13.9
Power Use Rated/Max (kw): Cooling	0.50/0.85	0.79/0.99	1.04/1.56
Heating	0.66/1.93	1.01/1.94	1.15/2.19
Fan Speeds Stage	4+Auto	4+Auto	4+Auto
Air Direction: Horizontal	Automatic	Automatic	Automatic
Vertical	Automatic	Automatic	Automatic
Air Filter	Washable	Washable	Washable
Connection Method	Flare	Flare	Flare
Combined Min. Lgth Ft (m)	10 (3)	10 (3)	10 (3)
Combined Max. Lgth Ft (m)	66 (20) (pre-charge: 49')	66 (20) (pre-charge: 49')	66 (20) (pre-charge: 49')
Max. Vertical Diff. Ft (m)	49 (15)	49 (15)	49 (15)
Conn. Pipe Diameter Inch	Suc.3/8 Dis.1/4	Suc.3/8 Dis.1/4	Suc.1/2 Dis.1/4
Net Weight lbs. (kg)	31 (14) 84 (38)	31 (14) 84 (38)	31 (14) 86 (39)
Dimensions: Height Inch	11-5/8 24-7/16	11-5/8 24-7/16	11-5/8 24-7/16
mm	295 620	295 620	295 620
Width Inch	37 31-1/8	37 31-1/8	37 31-1/8
mm	940 790	940 790	940 790
Depth Inch	10-5/8 11-7/16	10-5/8 11-7/16	10-5/8 11-7/16
mm	270 290	270 290	270 290
Refrigerant	R410A	R410A	R410A
Indoor ASU9RLS3	Indoor ASU12RLS3	Indoor ASU15RLS3	
Outdoor AOU9RLS3	Outdoor AOU12RLS3	Outdoor AOU15RLS3	

Note: Figures are based on 230 Volts.

Wall Mounted High-Heat 9, 12 and 15,000 BTU Systems

SYSTEMS 9RLS3H, 12RLS3H, 15RLS3H



Up to 14.0 HSPF

ESP Energy Saving Program

ESP senses when you leave a room and 20 minutes later, set temperature is increased by 4°F when cooling and reduced by 8°F when heating. When you come back to the room, it returns to previous operating mode. This feature can be deactivated if chosen.

High Performance Heating

Heating capacity at low outdoor temperatures was improved by adopting a large heat exchanger and a high capacity compressor. Standard rated heating capacity is maintained down to 3°F. RLS3H models will deliver more than 73% of rated heating capacity at -15°F.

Base Pan Heater

- Equipped with a base heater that prevents condensate from freezing
- Cultivated base design discharges melted water through many holes.
- Without a heater, freezing condensate can cause noise, damage to fan blade, condenser, and system performance



Drain hole is not filled, no freezing of base | Freezing where there is no heater | Drain hole is closed, large freezing of base

Condition: Indoor temp. of 68°FDB / outdoor temp. of 5°FDB, Heating mode, High airflow volume. Operation for 24 hours.

Optional Accessories

- Wired Remote Controller: UTY-RVNUM
Backlit and includes room temperature
- Wired Remote Controller: UTY-RNNUM
- Simple Remote Controller: UTY-RSNUM
- Communication Kit: UTY-TWBXF1
- Dry Contact Wire Kit: UTY-XWZXZ5



*Applies when properly registered AND installed by a Fujitsu Elite Contractor in a residence. See full warranty for details.

	9RLS3H Heat Pump	12RLS3H Heat Pump	15RLS3H Heat Pump
Nominal Cooling BTU/h	9,000	12,000	14,500
Min.~Max. Cooling BTU/h	3,100~12,000	3,100~13,600	3,100~18,400
Nominal Heating BTU/h	12,000	16,000	18,000
Min.~Max. Heating BTU/h	3,100~22,000	3,100~22,100	3,100~23,900
HSPF BTU/hW	14.0	13.8	13.3
SEER BTU/hW	33.0	29.3	25.3
EER Clg	18.0	15.2	13.9
Clg. Operating Range °F(°C)	14~115 (-10~46)	14~115 (-10~46)	14~115 (-10~46)
Htg. Operating Range °F(°C)	-15~75 (-26~24)	-15~75 (-26~24)	-15~75 (-26~24)
Moisture Removal Pt./h(l/h)	2.6 (1.2)	2.7 (1.3)	4.0 (1.9)
Voltage/Frequency/Phase	208-230/60/1	208-230/60/1	208-230/60/1
MAX.CRT.BKR (A)	15	15	20
Air Circ. C.F.M. (m ³ /h):			
Hi	489 (830)	489 (830)	547 (930)
Medium	400 (680)	400 (680)	459 (780)
Low	341 (580)	341 (580)	371 (630)
Quiet	224 (380)	224 (380)	Clg 259 (440) Htg 294 (500)
Noise Level dB(A) Clg/Htg:			
Hi	42/41	42/41	45/45
Medium	37/35	37/35	40/39
Low	32/31	32/31	34/33
Quiet	23/23	23/23	26/27
Outdoor Noise Level dB(A) Clg/Htg	42/47	43/47	49/50
Current Rated/Max (A):			
Cooling	2.5/9.4	3.8/9.4	4.8/9.9
Heating	3.3/10.0	4.7/11.9	5.2/13.9
Power Use Rated/Max (kw):			
Cooling	0.50/0.85	0.79/0.99	1.04/1.56
Heating	0.66/1.93	1.01/1.94	1.15/2.19
Fan Speeds Stage	4+Auto	4+Auto	4+Auto
Air Direction: Horizontal	Automatic	Automatic	Automatic
Vertical	Automatic	Automatic	Automatic
Air Filter	Washable	Washable	Washable
Connection Method	Flare	Flare	Flare
Combined Min. Lgth Ft (m)	10 (3)	10 (3)	10 (3)
Combined Max. Lgth Ft (m)	66 (20) (pre-charge: 49')	66 (20) (pre-charge: 49')	66 (20) (pre-charge: 49')
Max. Vertical Diff. Ft (m)	49 (15)	49 (15)	49 (15)
Conn. Pipe Diameter Inch	Suc.3/8 Dis.1/4	Suc.3/8 Dis.1/4	Suc.1/2 Dis.1/4
Net Weight lbs. (kg)	31 (14) 86 (39)	31 (14) 86 (39)	31 (14) 88 (40)
Dimensions: Height Inch	11-5/8 24-7/16	11-5/8 24-7/16	11-5/8 24-7/16
mm	295 620	295 620	295 620
Width Inch	37 31-1/8	37 31-1/8	37 31-1/8
mm	940 790	940 790	940 790
Depth Inch	10-5/8 11-7/16	10-5/8 11-7/16	10-5/8 11-7/16
mm	270 290	270 290	270 290
Refrigerant	R410A	R410A	R410A
Indoor	ASU9RLS3	ASU12RLS3	ASU15RLS3
Outdoor	AOU9RLS3H	AOU12RLS3H	AOU15RLS3H

Note: Figures are based on 230 Volts.

Wall Mounted HFI Single Zone 9, and 12,000 BTU

9RLF1, 12RLF1

(COMPATIBLE ONLY WITH HFI WALL MOUNT UNIT)



Standard Features

- Wireless Remote Control
- Apple Catechin Filter
- Ion Deodorizing Filter
- Sleep Timer
- 24-Hour Timer
- Weekly Timer*
- Dry Mode
- Auto Louver: Up/Down
- Auto Mode
- Minimum Heat Mode
- Economy Mode
- Quiet Mode
- Auto Restart/Reset
- Auto Changeover
- Low Ambient Cooling
- Cold Prevention
- Remote Temp. Sensor*
- 3rd Party Device Control**

* Available only with optional wired remote controller.
** Operation monitoring and On/Off control only.

Built In Filtration

Long-life Ion Deodorization Filter
The filter deodorizes by powerfully decomposing absorbed odors using the oxidizing and reducing effects of ions generated by the ultra-fine particle ceramic.

+ The filter can be used for approximately 3 years if it is washed with water when dirty to restore its surface action.

Apple-Catechin Filter
Dust, mold spores and micro-organisms are absorbed onto the filter by static electricity and growth is inhibited and deactivated. Filter lasts 3-12 months.

Optional Accessories

- Wired Remote Controller: UTY-RVNUM*
Backlit and includes room temperature
- Wired Remote Controller: UTY-RNNUM*
- Simple Remote Controller: UTY-RSNUM*
- Dry Contact Wire Kit: UTY-XWZXZ5
- Interface Kit: UTY-XCBXZ2



* Wall mounted ASU9, 12RLF1 require accessory interface kit #UTY-XCBXZ2 in order to connect these devices to them.



*Applies when properly registered AND installed by a Fujitsu Elite Contractor in a residence. See full warranty for details.

	9RLF1 Heat Pump	12RLF1 Heat Pump
Nominal Cooling BTU/h	9,000	12,000
Min.~Max. Cooling BTU/h	1,700~10,900	3,100~13,300
Nominal Heating BTU/h	12,000	16,000
Min.~Max. Heating BTU/h	1,700~15,000	3,100~19,100
HSPF BTU/hW	11.0	11.0
SEER BTU/hW	23.0	22.0
EER Clg	13.8	12.5
Clg. Operating Range °F(°C)	14~115 (-10~46)	14~115 (-10~46)
Htg. Operating Range °F(°C)	5~75 (-15~24)	5~75 (-15~24)
Moisture Removal Pt./h(h)	2.75 (1.3)	3.80 (1.8)
Voltage/Frequency/Phase	208-230/60/1	208-230/60/1
MAX.CRT.BKR (A)	20	20
Air Circ. C.F.M. (m ³ /h): Hi	441 (750)	441 (750)
Medium	376 (640)	376 (640)
Low	282 (480) Clg 306 (520) Htg	282 (480) Clg 306 (520) Htg
Quiet	182 (310) Clg 194 (330) Htg	182 (310) Clg 194 (330) Htg
Noise Level dB(A) (Clg/Htg): Hi	43/43	43/43
Medium	40/38	40/38
Low	32/33	32/33
Quiet	21/22	21/22
Outdoor Noise Level dB(A) Clg/Htg	48/48	49/49
Current Rated/Max (A): Cooling	3.2/6.0	4.4/6.5
Heating	4.2/7.5	5.9/9.0
Power Use Rated/Max (kw): Cooling	0.65/1.27	0.96/1.40
Heating	0.89/1.60	1.28/1.99
Fan Speeds Stage	4+Auto	4+Auto
Air Direction: Horizontal	Manual	Manual
Vertical	Automatic	Automatic
Air Filter	Washable	Washable
Apple Catechin Filter	Yes	Yes
Connection Method	Flare	Flare
Combined Min. Lgth Ft (m)	10 (3)	10 (3)
Combined Max. Lgth Ft (m)	66 (20.1) (pre-charge: 49')	66 (20.1) (pre-charge: 49')
Max. Vertical Diff. Ft (m)	49 (15)	49 (15)
Conn. Pipe Diameter Inch	Suc. 3/8 Dis. 1/4	Suc. 3/8 Dis. 1/4
Net Weight lbs. (kg)	18 (8) 60 (27)	18 (8) 80 (36)
Dimensions: Height Inch	10-1/2	21-1/4 10-1/2 21-1/4
mm	268 540	268 540
Width Inch	33-1/16	26 33-1/16 31
mm	840	660 840 790
Depth Inch	8	11-7/16 8 11-7/16
mm	203	290 203 290
Refrigerant	R410A	R410A
Indoor ASU9RLF1		
Outdoor AOU9RLF1W1		
Indoor ASU12RLF1		
Outdoor AOU12RLF1W1		

Note: Figures are based on 230 Volts.

Wall Mounted HFI Single Zone 18, and 24,000 BTU

18RLXFW1, 24RLXFW1

(COMPATIBLE ONLY WITH HFI WALL MOUNT UNIT)



Up to 20 SEER

Standard Features

- | | |
|-------------------------|----------------------------|
| Wireless Remote Control | Quiet Mode |
| Apple Catechin Filter | Power Diffuser |
| Ion Deodorizing Filter | Auto Restart/Reset |
| Sleep Timer | Auto Changeover |
| 24-Hour Timer | Low Ambient Cooling |
| Weekly Timer* | Long Piping Length |
| Dry Mode | Cold Prevention |
| Auto Louver: 4-way | Remote Temp. Sensor* |
| Auto Mode | Pump Down Operation |
| Minimum Heat Mode | 3rd Party Device Control** |
| Economy Mode | Expanded Heating Perform. |

* Available only with optional wired remote controller.

** Operation monitoring and On/Off control only.

High Performance Heating Capacity

Stay comfortable at low ambient temperatures! These systems can deliver 100% of rated heating capacity at 5°F (-15°C) and operates down to -5°F (-21°C).

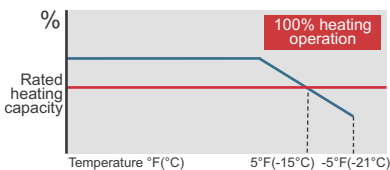

Optional Accessories

- Wired Remote Controller: UTY-RVNUM
Backlit and includes room temperature
- Wired Remote Controller: UTY-RNNUM
- Simple Remote Controller: UTY-RSNUM
- Dry Contact Wire Kit: UTY-XWZX



UTY-RVNUM

#Adapter Fittings

Supplied in outdoor unit to be installed on the indoor unit.

- | | | | |
|---|--|----------------------------|--|
| 1/4FF x 3/8MF
For 18RLF
and 24RLF | | 1/2FF x 5/8MF
For 18RLF | |
|---|--|----------------------------|--|



* Applies when properly registered AND installed by a Fujitsu Elite Contractor in a residence. See full warranty for details.

	18RLXFW1 Heat Pump	24RLXFW1 Heat Pump
Nominal Cooling BTU/h	18,000	22,000
Min.~Max. Cooling BTU/h	7,000~23,000	9,900~27,300
Nominal Heating BTU/h	21,600	25,200
Min.~Max. Heating BTU/h	7,000~29,000	7,500~36,200
HSPF BTU/hW	10.5	10.6
SEER BTU/hW	20.0	19.5
EER Clg	13.3	12.5
Clg. Operating Range °F(°C)	-5~115 (-20~46)	-5~115 (-20~46)
Htg. Operating Range °F(°C)	-5~75 (-20~24)	-5~75 (-20~24)
Moisture Removal Pt.h(l/h)	5.9 (2.8)	6.3 (3.0)
Voltage/Frequency/Phase	208-230/60/1	208-230/60/1
MAX.CRT.BKR (A)	20	30
Air Circ. C.F.M. (m ³ /h): Hi	541 (920)	659 (1,120) Clg 677 (1,150) Htg
Medium	435 (740)	530 (900)
Low	365 (620)	435 (740)
Quiet	306 (520) Clg 318 (540) Htg	365 (620)
Noise Level dB(A) (Clg/Htg): Hi	43/44	49/49
Medium	37/37	42/42
Low	33/33	37/37
Quiet	28/28	33/33
Outdoor Noise Level dB(A) Clg/Htg	47/50	54/55
Current Rated/Max (A): Cooling	6.2/13.5	7.9/15.0
Heating	7.8/14.5	8.6/15.5
Power Use Rated/Max (kw): Cooling	1.35/3.01	1.76/3.42
Heating	1.80/3.23	2.38/3.53
Fan Speeds Stage	4+Auto	4+Auto
Air Direction: Horizontal	Automatic	Automatic
Vertical	Automatic	Automatic
Air Filter	Washable	Washable
Apple Catechin Filter	Yes	Yes
Connection Method	Flare	Flare
Combined Min. Lgth Ft (m)	16 (5)	16 (5)
Combined Max. Lgth Ft (m)	164 (50) (pre-charge: 66')	164 (50) (pre-charge: 66')
Max. Vertical Diff. Ft (m)	98 (30)	98 (30)
Conn. Pipe Diameter Inch	Suc. 5/8* Dis. 3/8*	Suc. 5/8* Dis. 3/8*
Net Weight lbs. (kg)	31 (14)	134 (61)
Dimensions: Height Inch	12-5/8	32-3/4
mm	320	830
Width Inch	39-1/4	35-3/8
mm	998	900
Depth Inch	9	13
mm	228	330
Refrigerant	R410A	R410A

Indoor ASU18RLF
Outdoor AOU18RLXFW1
Indoor ASU24RLF
Outdoor AOU24RLXFW1

Note: Figures are based on 230 Volts.

Wall Mounted High-Heat 18 and 24,000 BTU Systems

SYSTEMS 18RLXFWH, 24RLXFWH



Up to 20 SEER

Standard Features

- Wireless Remote Control
- Apple Catechin Filter
- Ion Deodorizing Filter
- Sleep Timer
- Weekly Timer
- Dry Mode
- Auto Louver: 4-Way
- Auto Mode
- Minimum Heat (50°F/10°C)
- Economy Mode
- Quiet Mode (Indoor)
- Power Diffuser
- Auto Restart/Reset
- Auto Changeover
- Low Ambient Cooling
- Blue Fin Heat Exchanger
- Long Piping Length
- Base Pan Heater
- Third Party Device Control
- Cold Prevention

Improved Heating Capacity

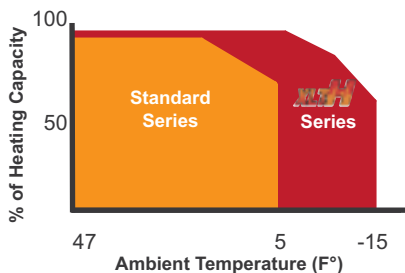

Heating capacity at low outdoor temperatures was improved by adopting a large heat exchanger and a high capacity compressor.

Base Pan Heater

- Equipped with a base heater that prevents condensate from freezing
- Cultivated base design discharges melted water through many holes.
- Without a heater, freezing condensate can cause noise, damage to fan blade, condenser, and system performance



Optional Accessories

- Wired Remote Controller: UTY-RVNUM
Backlit and includes room temperature
- Wired Remote Controller: UTY-RNNUM
- Simple Remote Controller: UTY-RSNUM
- Dry Contact Wire Kit: UTY-XWZX



*Applies when properly registered AND installed by a Fujitsu Elite Contractor in a residence. See full warranty for details.

	18RLXFWH Heat Pump	24RLXFWH Heat Pump
Nominal Cooling BTU/h	18,000	22,000
Min.~Max. Cooling BTU/h	7,000~23,000	9,900~27,300
Nominal Heating BTU/h	21,600	25,200
Min.~Max. Heating BTU/h	7,000~29,000	7,500~36,200
HSPF BTU/hW	10.4	10.5
SEER BTU/hW	20.0	19.5
EER Clg	13.3	12.5
Clg. Operating Range °F(°C)	-5~-115 (-20~-46)	-5~-115 (-20~-46)
Htg. Operating Range °F(°C)	-15~-75 (-26~-24)	-15~-75 (-26~-24)
Moisture Removal Pt./h(l/h)	5.9 (2.8)	6.3 (3.0)
Voltage/Frequency/Phase	208-230/60/1	208-230/60/1
MAX.CRT.BKR (A)	20	20
Air Circ. C.F.M. Clg/Htg (m³/h): Hi	541 (920)	659 (1,120) / 677 (1,150)
Medium	435 (740)	530 (900)
Low	365 (620)	435 (740)
Quiet	306 (520) / 318 (540)	365 (620)
Noise Level dB(A) Clg/Htg: Hi	43/44	49/49
Medium	37/37	42/42
Low	33/33	37/37
Quiet	28/28	33/33
Outdoor Noise Level dB(A) Clg/Htg	47/50	54/55
Current Rated (A): Cooling	6.2	7.9
Heating	7.8	8.6
Power Use Rated/Max (kw): Cooling	1.35/3.01	1.76/3.42
Heating	1.75/3.23	1.94/3.53
Fan Speeds Stage	4+Auto	4+Auto
Air Direction: Horizontal	Automatic	Automatic
Vertical	Automatic	Automatic
Air Filter	Washable	Washable
Connection Method	Flare	Flare
Combined Min. Lgth Ft (m)	16 (5)	16 (5)
Combined Max. Lgth Ft (m)	164 (50) (pre-charge: 65')	164 (50) (pre-charge: 65')
Max. Vertical Diff. Ft (m)	98 (30)	98 (30)
Conn. Pipe Diameter Inch	Suc.3/8 Dis.5/8	Suc.3/8 Dis.5/8
Net Weight lbs. (kg)	31 (14) 135 (61)	31 (14) 135 (61)
Dimensions: Height Inch	12-5/8 320	12-5/8 320
mm	320 830	320 830
Width Inch	39-1/4 998	39-1/4 998
mm	998 900	998 900
Depth Inch	9 228	9 228
mm	228 330	228 330
Refrigerant	R410A	R410A

Indoor ASU18RLF
Outdoor AOU18RLXFWH
Indoor ASU24RLF
Outdoor AOU24RLXFWH

Note: Figures are based on 230 Volts.

Wall Mounted High-Heat 30,000 BTU System

SYSTEM 30RLXEH



Up to 18.7 SEER

Standard Features

- | | |
|--------------------------|----------------------------|
| Wireless Remote Control | Quiet Mode (Indoor) |
| Apple Catechin Filter | Low Noise Mode |
| Ion Deodorizing Filter | Power Diffuser |
| Sleep Timer | Auto Restart/Reset |
| Weekly Timer | Auto Changeover |
| Dry Mode | Low Ambient Cooling |
| Auto Louver: 4-Way | Blue Fin Heat Exchanger |
| Auto Mode | Long Piping Length |
| Powerful Operation Mode | Base Pan Heater |
| Minimum Heat (50°F/10°C) | Third Party Device Control |
| Economy Mode | Cold Prevention |
| Energy Saving Program | Pump Down Operation |

Extended Line Set

Long piping lengths between indoor and outdoor units provides flexibility and increased applications.

Max Pipe Length
System 30RLXEH
246 ft. (75m)

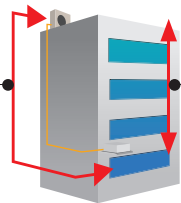

Max Height Diff.
98 ft.
(30m)

Lock Out Function

This feature is set by the contractor on behalf of the Commercial Property Owner to prevent either Cooling or Heating operation from occurring. This is not a function that can be set by a tenant, user, or home owner.

Lead Lag Control[†]

- Alternate operation of systems
- Back up operation of redundant system
- Dual stage operation

Optional Accessories

- Wired Touch Panel Remote Controller: UTY-RNRUZ1[†]
Backlit and includes room temperature
- Wired Remote Controller: UTY-RVNUM[†]
Backlit and includes room temperature
- Wired Remote Controller: UTY-RNNUM[†]
- Simple Remote Controller: UTY-RSNUM[†]
- Dry Contact Wire Kit: UTY-XWZX
- Interface Kit: UTY-XCSXZ1
- Interface Kit Box: UTZ-GXXB
- Outdoor Unit Input/Output Connector: UTY-XWZXZ3



[†] Wired remotes cannot be used when using this feature. This includes UTY-RNRUZ1, UTY-RVNUM, UTY-RNNUM, UTY-RSNUM.

30RLXEH Heat Pump

Nominal Cooling BTU/h	30,000
Min.~Max. Cooling BTU/h	9,900~32,400
Nominal Heating BTU/h	32,000
Min.~Max. Heating BTU/h	8,000~37,500
HSPF BTU/hW	11.7
SEER BTU/hW	18.7
EER Clg	12.5
Clg. Operating Range °F(°C)	-5~115 (-20~46)
Htg. Operating Range °F(°C)	-15~75 (-26~24)
Moisture Removal Pt./h(l/h)	9.7 (4.6)
Voltage/Frequency/Phase	208-230/60/1
MAX.CRT.BKR (A)	30
Air Circ. C.F.M. Clg/Htg (m ³ /h): Hi	812 (1,380)
Medium	665 (1,130)
Low	536 (910)
Quiet	418 (710)
Noise Level dB(A) Clg/Htg: Hi	50/49
Medium	45/44
Low	38/38
Quiet	32/32
Outdoor Noise Level dB(A) Clg/Htg	53/54
Current Rated (A): Cooling	10.6
Heating	12.0
Power Use Rated/Max (kw): Cooling	2.40/3.83
Heating	2.74/4.28
Fan Speeds Stage	4+Auto
Air Direction: Horizontal	Automatic
Vertical	Automatic
Air Filter	Washable
Connection Method	Flare
Combined Min. Lgth Ft (m)	16 (5)
Combined Max. Lgth Ft (m)	246 (75)
	(pre-charge: 65')
Max. Vertical Diff. Ft (m)	98 (30)
Conn. Pipe Diameter Inch	Suc.3/8 Dis.5/8
Net Weight lbs. (kg)	40 (18) 205 (93)
Dimensions: Height Inch	13-3/8 50-13/16
mm	340 1,290
Width Inch	45-1/4 35-3/8
mm	1,150 900
Depth Inch	11 13
mm	280 330
Refrigerant	R410A

Indoor
ASU30RLE
Outdoor
AOU30RLXEH

*Applies when properly registered AND installed by a Fujitsu Elite Contractor in a residence. See full warranty for details.

Note: Figures are based on 230 Volts.

Wall Mounted 18, 24, 30 and 36,000 BTU Heat Pumps

SYSTEMS 18RLB, 24RLB, 30RLXB, 36RLXB



Up to 19.0 SEER

AOU18RLB AOU30RLXB
AOU24RLB AOU36RLXB

Function

Stylish, slim and elegant, these wall mounted ductless heat pumps are designed for single rooms. Ideal for spaces requiring additional capacity but are limited on space. With more efficient zone control, "ductless mini-splits" are perfect for renovations, restorations, conversions, and add-ons.

Lock Out Function

This feature is set by the contractor on behalf of the Commercial Property Owner to prevent either Cooling or Heating operation from occurring. This is not a function that can be set by a tenant, user, or home owner.

Standard Features

- Wireless Remote Control
- Apple Catechin Filter
- Ion Deodorizing Filter
- Sleep Timer
- Auto Louver: 4-Way
- Auto Mode
- Minimum Heat Mode
- Economy Mode
- Auto Restart/Reset
- Auto Changeover



Standard wireless remote control

Optional Accessories

- Wired Remote Controller: UTY-RVNUM
Backlit and includes room temperature
- Wired Remote Controller: UTY-RNNUM
- Simple Remote Controller: UTY-RSNUM
- Dry Contact Wire Kit: UTY-XWZX



*Applies when properly registered AND installed by a Fujitsu Elite Contractor in a residence. See full warranty for details.

	18RLB Heat Pump	24RLB Heat Pump	30RLXB Heat Pump	36RLXB Heat Pump
Nominal Cooling BTU/h	18,000	24,000	30,000	33,000
Min.-Max. Cooling BTU/h	3,100~19,000	3,100~25,000	9,900~32,400	9,900~34,100
Nominal Heating BTU/h	18,000	24,000	30,000	34,000
Min.-Max. Heating BTU/h	7,000~20,000	7,500~27,000	8,000~33,000	10,200~35,000
HSPF BTU/hW	10.6	10.6	9.0	9.0
SEER BTU/hW	19.0	18.0	16.5	15.5
EER Clg	12.5	10.0	9.5	8.5
Clg. Operating Range °F(°C)	14~115 (-10~46)	14~115 (-10~46)	14~115 (-10~46)	14~115 (-10~46)
Htg. Operating Range °F(°C)	5~75 (-15~24)	5~75 (-15~24)	5~75 (-15~24)	5~75 (-15~24)
Moisture Removal Pt./h(l/h)	4.0 (1.9)	6.3 (3.0)	9.7 (4.6)	10.1 (4.8)
Voltage/Frequency/Phase	208-230/60/1	208-230/60/1	208-230/60/1	208-230/60/1
MAX.CRT.BKR (A)	15	20	30	30
Air Circ. C.F.M. (m ³ /h): Hi	542 (920)	659 (1,120) Clg 647 (1,100) Htg	659 (1,120) Clg 677 (1,150) Htg	695 (1,180)
Medium	439 (740)	530 (900)	530 (900)	530 (900)
Low	365 (620)	436 (740)	436 (740)	436 (740)
Quiet	306 (520)	365 (620)	365 (620)	365 (620)
Noise Level dB(A) (Clg/Htg): Hi	42/43	47/47	47/49	50/50
Medium	35/36	41/42	42/42	42/42
Low	31/33	35/36	37/37	37/37
Quiet	26/28	31/33	32/33	32/33
Outdoor Noise Level Clg/Htg dB(A)	51/50	54/55	52/55	52/55
Current Rated/Max (A): Cooling	6.4/8.3	10.5/11.8	13.8/16.8	17.0/18.0
Heating	5.8/11.8	8.5/13.8	12.3/18.8	14.8/18.8
Power Use Rated/Max (kw): Cooling	1.44/1.89	2.40/2.69	3.16/3.83	3.88/4.10
Heating	1.29/2.69	1.93/3.14	2.80/4.28	3.39/4.28
Fan Speeds Stage	4+Auto	4+Auto	4+Auto	4+Auto
Air Direction: Horizontal	Automatic	Automatic	Automatic	Automatic
Vertical	Automatic	Automatic	Automatic	Automatic
Air Filter	Washable	Washable	Washable	Washable
Connection Method	Flare	Flare	Flare	Flare
Combined Min. Lgth Ft (m)	10 (3)	10 (3)	16 (5)	16 (5)
Combined Max. Lgth Ft (m)	66 (20)	66 (20)	165 (50)	165 (50)
	(pre-charge: 49')	(pre-charge: 49')	(pre-charge: 66')	(pre-charge: 66')
Max. Vertical Diff. Ft (m)	49 (15)	49 (15)	98 (30)	98 (30)
Conn. Pipe Diameter Inch	Suc.1/2 Dis.1/4	Suc.1/2 Dis.1/4	Suc.5/8 Dis.3/8	Suc.5/8 Dis.3/8
Net Weight lbs. (kg)	31 (14) 86 (39)	31 (14) 86 (39)	31 (14) 134 (61)	31 (14) 134 (61)
Dimensions: Height Inch	12-5/8 24-7/16	12-5/8 24-7/16	12-5/8 32-11/16	12-5/8 32-11/16
mm	320 620	320 620	320 830	320 830
Width Inch	39-5/16 31-1/8	39-5/16 31-1/8	39-5/16 35-7/16	39-5/16 35-7/16
mm	998 790	998 790	998 900	998 900
Depth Inch	9 11-7/16	9 11-7/16	9 13	9 13
mm	228 290	228 290	228 330	228 330
Refrigerant	R410A	R410A	R410A	R410A
Indoor	ASU18RLB	ASU24RLB	ASU30RLXB	ASU36RLXB
Outdoor	AOU18RLB	AOU24RLB	AOU30RLXB	AOU36RLXB

Note: Figures are based on 230 Volts.

Ceiling and Universal Floor/Ceiling Mounted Systems

SYSTEMS 18RULX, 24RULX, 36RSLX



Up to 16 SEER

Function

The 18RULX and the 24RULX are universal mount. They can mount low on the wall or transverse mount them on the ceiling. The 36RSLX can only be mounted on the ceiling, can take in fresh air and can throw air farther.

Standard Features

- Wireless Remote Control
- Sleep Timer
- 24 Hour Timer
- Dry Mode
- Auto Louver: 4 Way
- Auto Mode
- Auto Restart/Reset
- Auto Changeover
- 0°F Ambient Cooling
- Long Piping Length
- Cold Prevention
- Energy Saver*
- Remote Temp. Sensor*
- Daisy Chain
- Pump Down Operation
- High Ceiling Mode
- Fresh Air Intake^

*Available only with optional wired remote controller.
^Fresh air knockout available. Fresh air fan and ductwork field supplied.
See Design and Technical Manual for details

Optional Accessories

- Wired Remote Control UTY-RNBYU*
 - Weekly Timer
 - Full Function Wired Remote
 - Child Lock Capable

*Requires dip switch change on indoor unit.
- Condensate Pump UTR-DP24T
 - OEM design plug and play
 - Rated for 11.8" of vertical lift.

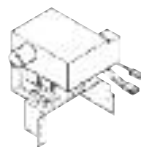

Applications

The universal mount 18RULX and 24RULX are ideal for a house of worship to mount beneath stained glass windows. Lower in height than the pews, they do not disturb the aesthetics of the space. With long piping lengths of 165' the outdoor units can also be placed remotely out of sight. Another popular application for this model is in hallways where wall space is limited. The 36RSLX is popular where fresh air intake and high capacity is required like a restaurant or bar. They are also often suspended from threaded rod and used in multiple to condition large warehouse spaces.

	18RULX Heat Pump	24RULX Heat Pump	36RSLX Heat Pump
Nominal Cooling BTU/h	17,800	22,200	34,100
Min.~Max. Cooling BTU/h	5,000~21,600	5,000~27,300	8,500~36,000
Nominal Heating BTU/h	21,500	24,000	36,500
Low Heating 17°F BTU/h	13,000	15,000	23,400
Min.~Max. Heating BTU/h	5,000~25,600	5,000~29,000	9,200~42,700
HSPF BTU/hW	8.5	8.5	8.5
SEER BTU/hW	16.0	15.0	14.0
EER Clg	10.9	9.9	8.1
Clg. Operating Range °F(°C)	0~115 (-18~46)	0~115 (-18~46)	0~115 (-18~46)
Htg. Operating Range °F(°C)	14~75 (-10~24)	14~75 (-10~24)	14~75 (-10~24)
Moisture Removal Pt./h(l/h)	5.3 (2.5)	7.4 (3.5)	7.4 (3.5)
Voltage/Frequency/Phase	208-230/60/1	208-230/60/1	208-230/60/1
MAX.CRT.BKR (A)	20	20	30
Air Circ. C.F.M. (m³/h): Hi	459 (780)	518 (880)	1089 (1850)
Medium	383 (650)	436 (740)	977 (1660)
Low	324 (550)	371 (630)	842 (1430)
Noise Level dB(A): Hi	43/43 (Clg/Htg)	47/47 (Clg/Htg)	48/48 (Clg/Htg)
Medium	39/39 (Clg/Htg)	43/43 (Clg/Htg)	45/43 (Clg/Htg)
Low	35/35 (Clg/Htg)	38/38 (Clg/Htg)	41/39 (Clg/Htg)
Outdoor Noise Level dB(A)	51/53	53/55	54/55
Current Rated/Max (A): Cooling	7.1/12.5	9.8/12.5	18.3/18.8
Heating	9.8/12.5	10.2/12.5	15.3/18.8
Power Use Rated/Max (kw): Cooling	1.63/2.88	2.25/2.88	4.22/4.35
Heating	2.25/2.88	2.35/2.88	3.50/4.35
Fan Speeds Stage	3 + Auto	3 + Auto	3 + Auto
Air Direction: Horizontal	Automatic	Automatic	Automatic
Vertical	Automatic	Automatic	Automatic
Air Filter	Washable	Washable	Washable
Front Grille	Permanent	Permanent	Permanent
Connection Method	Flare	Flare	Flare
Combined Min. Lgth Ft (m)	16 (5)	16 (5)	16 (5)
Combined Max. Lgth Ft (m)	165 (50) (pre-charge: 49')	165 (50) (pre-charge: 49')	165 (50) (pre-charge: 49')
Max. Vertical Diff. Ft (m)	66 (20)	66 (20)	98 (30)
Conn. Pipe Diameter Inch	Suc.1/2 Dis. 1/4	Suc.5/8 Dis. 3/8	Suc.5/8 Dis. 3/8
Net Weight lbs. (kg)	62 (28)	141 (64)	106 (48)
Dimensions: Height Inch	7-7/8	32-3/4	7-7/8
mm	199	830	199
Width Inch	39-1/8	35-1/2	39-1/8
mm	990	900	990
Depth Inch	25-7/8	13	25-7/8
mm	655	330	655
Refrigerant	R410A	R410A	R410A
Indoor ABU18RULX		Indoor ABU24RULX	
Outdoor AOU18RULX		Outdoor AOU24RULX	
Indoor ABU36RSLX		Outdoor AOU36RSLX	

Note: Figures are based on 230 Volts.



Floor Mount Single Zone 9, 12 and 15,000 BTU Systems

SYSTEMS 9RLFF, 12RLFF, 15RLFF



Up to 26 SEER



Floor mount systems are ideal for residential radiator replacements or any room with limited upper wall space.



At less than 24" high and 30" wide, floor mount models fit easily under a standard window and can replace a radiator twice its size while producing more capacity.

Standard Features for RLFF and RLFFH Models

- Wireless Remote Control
- Apple Catechin Filter
- Ion Deodorizing Filter
- Sleep Timer
- 24-Hour Timer
- Auto Louver: Up/Down
- Auto Mode
- Minimum Heat Mode
- Economy Mode
- Auto Restart/Reset
- Auto Changeover
- Powerful Mode

Flexible and Easy Installation

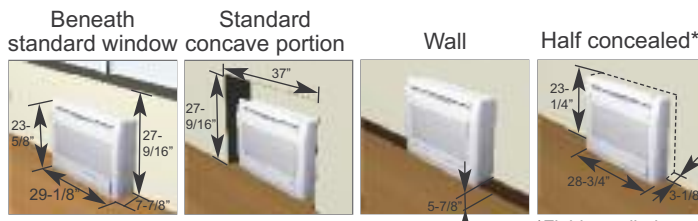

*Field supplied insulation required

Accessories for RLFF and RLFFH Models

- Wired Remote Controller: UTY-RVNUM
Backlit and includes room temperature
- Wired Remote Controller: UTY-RNNUM
- Simple Remote Controller: UTY-RSNUM
- Dry Contact Wire Kit: UTY-XWZXZ5



*Applies when properly registered AND installed by a Fujitsu Elite Contractor in a residence. See full warranty for details.

Low Temperature Heating Down to -5°F

	9RLFF Heat Pump	12RLFF Heat Pump	15RLFF Heat Pump
Nominal Cooling BTU/h	9,000	12,000	14,200
Min.~Max. Cooling BTU/h	3,100~13,000	3,100~14,300	3,100~17,700
Nominal Heating BTU/h	12,000	16,000	18,000
Min.~Max. Heating BTU/h	3,100~18,800	3,100~22,100	3,100~23,900
HSPF BTU/hW	12.6	11.6	11.2
SEER BTU/hW	26.0	22.7	20.3
EER Clg	16.0	13.1	12.5
Clg. Operating Range °F(°C)	14~115 (-10~46)	14~115 (-10~46)	14~115 (-10~46)
Htg. Operating Range °F(°C)	-5~75 (-21~24)	-5~75 (-21~24)	-5~75 (-21~24)
Moisture Removal Pt./h(h)	2.75 (1.3)	3.8 (1.8)	4.44 (2.1)
Voltage/Frequency/Phase	208-230/60/1	208-230/60/1	208-230/60/1
MAX.CRT.BKR (A)	15	15	20
Air Circ. C.F.M. (m/h): Hi	335 (570)	335 (570)	383 (650)
Medium	271 (460)	271 (460)	306 (520)
Low	212 (360)	212 (360)	235 (400)
Quiet	159 (270)	159 (270)	159 (270)
Noise Level dB(A)Clg/Htg: Hi	40/40	40/40	44/43
Medium	35/35	35/35	38/37
Low	29/29	29/29	31/29
Quiet	23/23	23/23	23/23
Outdoor Noise Level dB(A) Clg/Htg	50/50	52/52	54/54
Current Rated (A): Cooling	2.9	4.2	5.1
Heating	4.1	6.7	7.0
Power Use Rated (kw): Cooling	.56	.97	1.13
Heating	.88	1.44	1.58
Fan Speeds Stage	4+Auto	4+Auto	4+Auto
Air Direction: Horizontal	Manual	Manual	Manual
Vertical	Auto	Auto	Auto
Air Filter	Washable	Washable	Washable
Apple Catechin Filter	Yes	Yes	Yes
Ion Deodorizing Filter	Yes	Yes	Yes
Connection Method	Flare	Flare	Flare
Combined Min. Lgth Ft (m)	10 (3)	10 (3)	10 (3)
Combined Max. Lgth Ft (m)	66 (20) (pre-charge: 49')	66 (20) (pre-charge: 49')	66 (20) (pre-charge: 49')
Max. Vertical Diff. Ft (m)	49 (15)	49 (15)	49 (15)
Conn. Pipe Diameter Inch	Suc. 3/8 Dis. 1/4	Suc. 3/8 Dis. 1/4	Suc. 1/2 Dis. 1/4
Net Weight lbs. (kg)	31 (14)	84 (38)	31 (14)
Dimensions: Height Inch	23-5/8	24-7/16	23-5/8
mm	600	620	600
Width Inch	29-1/8	31-1/8	29-1/8
mm	740	790	740
Depth Inch	7-7/8	11-7/16	7-7/8
mm	200	290	200
Refrigerant	R410A	R410A	R410A
Indoor	AGU9RLFF	AGU12RLFF	AGU15RLFF
Outdoor	AOU9RLFF	AOU12RLFF	AOU15RLFF

Note: Figures are based on 230 Volts.

Floor Mount Single Zone 9, 12 and 15,000 BTU Systems

SYSTEMS 9RLFFH, 12RLFFH, 15RLFFH



Up to 26 SEER

Base Pan Heater RLFFH Models Only

- Equipped with a base heater that prevents condensate from freezing
- Cultivated base design discharges melted water through many holes.
- Without a heater, freezing condensate can cause noise, damage to fan blade, condenser, and system performance.

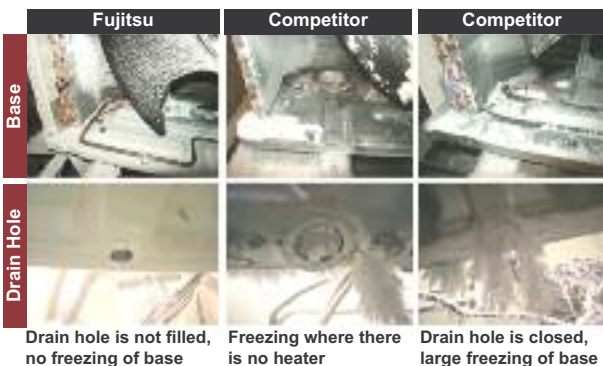

Drain hole is not filled, no freezing of base | Freezing where there is no heater | Drain hole is closed, large freezing of base

Condition: Indoor temp. of 68°FDB / outdoor temp. of 5°FDB, Heating mode, High airflow volume. Operation for 24 hours.

2-Fan and Wide Airflow

Having both upper and lower airflow quickly warms or cools the entire room. Floor mount can be set in "Upward Airflow Only" when occupants wish not to have feet warmed or cooled.

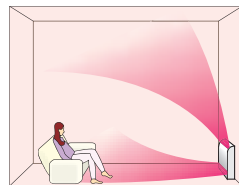

Applications



*Applies when properly registered AND installed by a Fujitsu Elite Contractor in a residence. See full warranty for details.

Extra Low Temperature Heating Down to -15°F

	9RLFFH Heat Pump	12RLFFH Heat Pump	15RLFFH Heat Pump
Nominal Cooling BTU/h	9,000	12,000	14,200
Min.-Max. Cooling BTU/h	3,100~13,000	3,100~14,300	3,100~17,700
Nominal Heating BTU/h	12,000	16,000	18,000
Min.-Max. Heating BTU/h	3,100~18,800	3,100~19,500	3,100~20,800
HSPF BTU/hW	12.4	11.3	11.0
SEER BTU/hW	26.0	22.7	20.3
EER Clg	16.0	13.1	12.5
Clg. Operating Range °F(°C)	14~115 (-10~46)	14~115 (-10~46)	14~115 (-10~46)
Htg. Operating Range °F(°C)	-15~75 (-26~24)	-15~75 (-26~24)	-15~75 (-26~24)
Moisture Removal Pt./h(lh)	2.75 (1.3)	3.8 (1.8)	4.44 (2.1)
Voltage/Frequency/Phase	208-230/60/1	208-230/60/1	208-230/60/1
MAX.CRT.BKR (A)	15	15	20
Air Circ. C.F.M. (m ³ /h): Hi	335 (570)	335 (570)	383 (650)
Medium	271 (460)	271 (460)	306 (520)
Low	212 (360)	212 (360)	235 (400)
Quiet	159 (270)	159 (270)	159 (270)
Noise Level dB(A)Clg/Htg: Hi	40/40	40/40	44/43
Medium	35/35	35/35	38/37
Low	29/29	29/29	31/29
Quiet	23/23	23/23	23/23
Outdoor Noise Level dB(A) Clg/Htg	50/50	52/52	54/54
Current Rated (A): Cooling	2.9	4.2	5.1
Heating	4.1	6.7	7.0
Power Use Rated (kw): Cooling	.56	.97	1.13
Heating	.88	1.44	1.58
Fan Speeds Stage	4+Auto	4+Auto	4+Auto
Air Direction: Horizontal	Manual	Manual	Manual
Vertical	Auto	Auto	Auto
Air Filter	Washable	Washable	Washable
Apple Catechin Filter	Yes	Yes	Yes
Ion Deodorizing Filter	Yes	Yes	Yes
Connection Method	Flare	Flare	Flare
Combined Min. Lgth Ft (m)	10 (3)	10 (3)	10 (3)
Combined Max. Lgth Ft (m)	66 (20)	66 (20)	66 (20)
	(pre-charge: 49')	(pre-charge: 49')	(pre-charge: 49')
Max. Vertical Diff. Ft (m)	49 (15)	49 (15)	49 (15)
Conn. Pipe Diameter Inch	Suc. 3/8 Dis. 1/4	Suc. 3/8 Dis. 1/4	Suc. 1/2 Dis. 1/4
Net Weight lbs. (kg)	31 (14)	86 (39)	31 (14)
	86 (39)	31 (14)	88 (40)
Dimensions: Height Inch	23-5/8	24-7/16	23-5/8
	24-7/16	23-5/8	24-7/16
mm	600	620	600
	620	600	620
Width Inch	29-1/8	31-1/8	29-1/8
	31-1/8	29-1/8	31-1/8
mm	740	790	740
	790	740	790
Depth Inch	7-7/8	11-7/16	7-7/8
	11-7/16	7-7/8	11-7/16
mm	200	290	200
	290	200	290
Refrigerant	R410A	R410A	R410A
Indoor	AGU9RLF	AGU12RLF	AGU15RLF
Outdoor	AOU9RLFFH	AOU12RLFFH	AOU15RLFFH

Note: Figures are based on 230 Volts.

Slim Duct Single Zone 9, 12 and 18,000 BTU Systems

SYSTEMS 9RLFCD, 12RLFCD, 18RLFCD

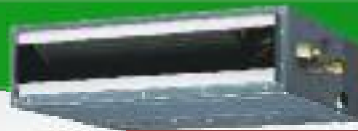

Up to 21.5 SEER



Function

Slim ducts provide comfort cooling or heating for small room applications. Features include high efficiency up to 21.5 SEER, heating at low temperatures down to -5°F, compact design, quiet operation, a standard wired remote control, and the ability to bring in fresh air.

High Performance Heating

Heating capacity at low outdoor temperatures is achieved by adopting a large heat exchanger and a high capacity compressor. Systems operate down to -5°F.

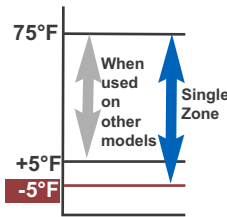

Standard Features

- Wired Remote Control
- Auto Changeover
- Weekly Timer
- Low Ambient Cooling
- Dry Mode
- Cold Prevention
- Auto Mode
- Daisy Chain
- Economy Mode
- Built-In Condensate Pump
- Minimum Heat*
- 3rd Party Device Control^
- Auto Restart/Reset

*Available only with optional wireless remote controller.
^Operation monitoring and On/Off control only.

Field Supplied Filters Used With Slim Duct Units

Although Slim Duct units come with factory filters, when return ductwork is used field supplied filters are more practical to use. They can be installed at the unit or for more convenient servicing, in filter grilles. See the guidelines to the right to determine filter sizes.

The chart includes CFM, external static pressure capability and a typical filter size for each model. Filters are sized to keep velocities and static pressure loss low. This will ensure sufficient static pressure is available for ductwork, fittings and supply and return grilles.

Alternative filter sizes with equivalent face areas can be used. After deducting filter loss, available static pressure values are shown.



A fiberglass filter is shown in blue to the left. A MERV pleated filter is shown in white.

Applications

Long maximum combined piping length of 66' and 49' in height allow for versatile installations. Flexible installation, either horizontal or vertical, and low height enables compact soffit or cabinet installation. These features make slim duct systems ideal for commercial applications such as offices, restaurants, convenience stores, motels, dorms, in retrofit and new construction.



Multi-Tenant Dwellings



Hotels / Motels



Dorms

Optional Accessories

- Backlit Wired Remote Control UTY-RVNUM *Displays room temp.*
- Wireless Remote and Receiver Unit UTY-LRHUM



UTY-RVNUM

System Components

- | | | |
|----------------------|-----------------------|-----------------------|
| System 9RLFCD | System 12RLFCD | System 18RLFCD |
| • ARU9RLF (Indoor) | • ARU12RLF (Indoor) | • ARU18RLF (Indoor) |
| • AOU9RLFC (Outdoor) | • AOU12RLFC (Outdoor) | • AOU18RLFC (Outdoor) |

	ARU 9RLF	ARU 12RLF	ARU 18RLF
CFM	353	383	547
Typical Filter Size	12 x 20	12 x 20	14 x 25
Velocity, FPM	212	230	228
Unit External SP, in. W.C.	0.36	0.36	0.36
1" Fiberglass Filter			
SP Loss, in. W.C.	0.04	0.05	0.04
Available Static Pressure	0.32	0.31	0.32
1" MERV 8 Pleated Filter			
SP Loss, in. W.C.	0.12	0.14	0.14
Available Static Pressure	0.24	0.22	0.22
2" MERV 8 Pleated Filter			
SP Loss, in. W.C.	0.07	0.08	0.08
Available Static Pressure	0.29	0.28	0.28

Slim Duct

Built-in drain pump allows for installation of slim duct unit in smaller spaces than traditional units.

Traditional



Compact Duct



Return Air-intake Choices

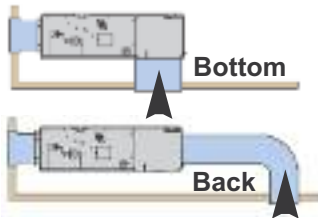

Flexible Installation

Horizontal or vertical.



*Internal drain pump will not operate when the unit is mounted in a vertical configuration.



*Applies when properly registered AND installed by a Fujitsu Elite Contractor in a residence. See full warranty for details.

	9RLFCF Heat Pump	12RLFCF Heat Pump	18RLFCF Heat Pump
Nominal Cooling BTU/h	9,000	12,000	18,000
Min~Max Cooling BTU/h	3,100~12,000	3,100~13,600	3,100~20,100
Nominal Heating BTU/h	12,000	16,000	21,600
Min~Max Heating BTU/h	3,100~18,000	3,100~19,400	3,100~25,600
HSPF	12.2	11.5	11.3
SEER	21.5	20.0	19.7
EER Clg	14.5	12.8	12.0
Cooling Operating Range °F(°C)	14~115 (-10~46)	14~115 (-10~46)	14~115 (-10~46)
Heating Operating Range °F(°C)	-5~75 (-21~24)	-5~75 (-21~24)	-5~75 (-21~24)
Moisture Removal Pt./h(l/h)	1.5 (.07)	2.7 (1.3)	4.2 (2.0)
Voltage/Frequency/Phase	208-230/60/1	208-230/60/1	208-230/60/1
MAX.CRT.BKR (A)	15	15	20
Static Pressure In. W. C.	0 ~ 0.36	0 ~ 0.36	0 ~ 0.36
Air Circ. C.F.M. (m ³ /h) Clg/Htg: Hi	353 (600)	383 (650)	554 (940)
Medium	324 (550)	353 (600)	518 (880)
Low	294 (500)	324 (550)	483 (820)
Quiet	265 (450)	283 (480)	442 (750)
Noise Level dB(A) (Clg/Htg): Hi	28/28	29/29	32/32
Medium	27/26	28/28	30/30
Low	26/25	27/27	29/29
Quiet	25/24	26/24	27/27
Outdoor Noise Level Clg/Htg	48/49	49/50	54/55
Running Current Rated (A)Clg/Htg	3.0/3.9	4.4/6.0	6.6/7.3
Power Use Rated/Max (kW): Cooling	0.62/1.40	0.94/1.45	1.50/2.15
Heating	0.85/1.80	1.30/2.00	1.67/2.60
Fan Speeds Stage	4 + Auto	4 + Auto	4 + Auto
Air Filter	Washable	Washable	Washable
Connection Method	Flare	Flare	Flare
Combined Min. Length Ft (m)	10 (3)	10 (3)	10 (3)
Combined Max. Length Ft (m)	66 (20) (pre-charge: 49')	66 (20) (pre-charge: 49')	66 (20) (pre-charge: 49')
Max. Vertical Diff. Ft (m)	49 (15)	49 (15)	49 (15)
Conn. Pipe Diameter Inch	suc 3/8 dis 1/4	suc 3/8 dis 1/4	suc 1/2 dis 1/4
Indoor Unit Net Weight lbs. (kg)	41 (19)	41 (19)	50 (23)
Outdoor Unit Net Weight lbs. (kg)	84 (38)	84 (38)	86 (39)
Indoor Unit Dimensions: Height Inch (mm)	7-25/32 (198)	7-25/32 (198)	7-25/32 (198)
Width Inch (mm)	27-9/16 (700)	27-9/16 (700)	35-7/16 (900)
Depth Inch (mm)	24-13/32 (620)	24-13/32 (620)	24-13/32 (620)
Supply Duct Flange Dimensions: Height Inch (mm)	5-15/16 (151)	5-15/16 (151)	5-15/16 (151)
Width Inch (mm)	25-19/32 (650)	25-19/32 (650)	33-15/32 (850)
Depth Inch (mm)	3/4 (19)	3/4 (19)	3/4 (19)
Return Duct Dimensions: Height Inch (mm)	6 (152)	6 (152)	6 (152)
Width Inch (mm)	22 (559)	22 (559)	30 (762)
Depth Inch (mm)	3/4 (19) (Flat)	3/4 (19) (Flat)	3/4 (19) (Flat)
Outdoor Unit Dimensions: Height Inch (mm)	24-1/2 (620)	24-1/2 (620)	24-1/2 (620)
Width Inch (mm)	31-3/32 (790)	31-3/32 (790)	31-3/32 (790)
Depth Inch (mm)	11-11/32 (290)	11-11/32 (290)	11-11/32 (290)
Refrigerant	R410A	R410A	R410A

Note: Figures are based on 230 Volts.

Compact Cassette Single Zone 9, 12 and 18,000 BTU

SYSTEMS 9RLFCC, 12RLFCC, 18RLFCC



Up to 24.0 SEER

Function

Compact cassettes provide comfort cooling or heating for small room applications. Features include high efficiency up to 24.0 SEER, heating at low temperatures down to -5°F, compact design, quiet operation, a standard wired remote control, and the ability to bring in fresh air through the optional Fresh Air Kit.

High Performance Heating

Heating capacity at low outdoor temperatures is achieved by adopting a large heat exchanger and a high capacity compressor. Systems operate down to -5°F.

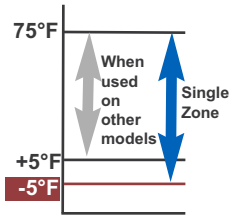

Standard Features

- Wired Remote Control
- Weekly Timer
- Dry Mode
- Auto Louver: Up/ Down
- Auto Mode
- Minimum Heat*
- Economy Mode
- Auto Restart/Reset
- Auto Changeover
- Low Ambient Cooling
- Cold Prevention
- Daisy Chain
- High Ceiling Mode
- Condensate Pump
- Fresh Air Intake**
- 3rd Party Device Control^



Fresh Air Kit**
UTZ-VXAA
Mixes room air then passes through the heat exchanger.

Optional Accessories

- Backlit Wired Remote Control UTY-RVNUM *Displays room temp.*
- Wireless remote UTY-LNHUM



UTY-RVNUM

Applications

Long maximum combined piping length of 66' and 49' in height allow for versatile installations. 4-way airflow, concealed flush mount design and the ability to operate in limited space above the drop ceiling, makes these systems ideal for commercial applications such as offices, restaurants, convenience stores, motels, dorms, in retrofit and new construction.



Multi-Tenant Dwellings



Hotels / Motels



Dorms



System Components

System 9RLFCC	System 12RLFCC	System 18RLFCC
• AUU9RLF (Indoor)	• AUU12RLF (Indoor)	• AUU18RLF (Indoor)
• AOU9RLF (Outdoor)	• AOU12RLF (Outdoor)	• AOU18RLF (Outdoor)

* Available only with optional wireless remote control.

**Requires Fujitsu's Optional Fresh Air Kit part #UTZ-VXAA. Allows for a 4-inch flex duct connection. Requires a field supplied duct booster fan capable of 60 CFM at .2"W.C. or 90 CFM at .4"W.C. For fan static pressure requirements, see installation manual. Add hood, filter and duct losses for fan total static pressure requirements. Will add 4" to the height of the indoor unit.

^ Operation monitoring and On/Off control only.

Easy Installation

Fits into a standard ceiling tile*.

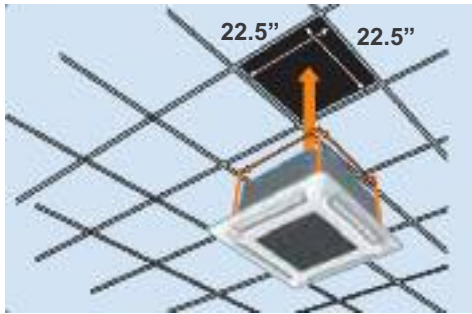

*Dimensions of outer grille are 27-9/16" x 27-9/16" and may overlap adjacent tiles.

2-Stage Turbo Fan

Air distribution is evenly spread across the heat exchanger by the 2 stage turbo fan which produces two separate airflow streams.

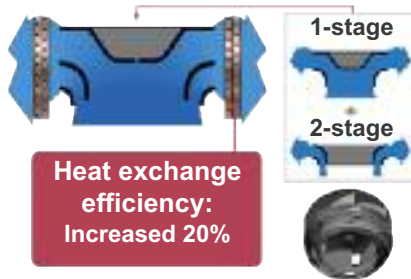

Quiet Operation

Optimization of wing form (laminar wing design) and number of wings (7 blades) enables as low as 27 dB.

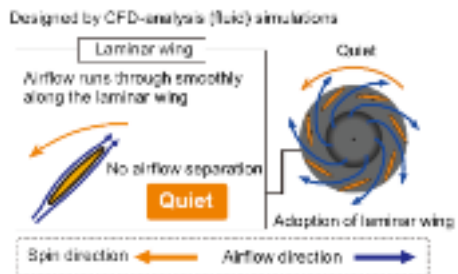

*Applies when properly registered AND installed by a Fujitsu Elite Contractor in a residence. See full warranty for details.

	9RLFCC Heat Pump	12RLFCC Heat Pump	18RLFCC Heat Pump
Nominal Cooling BTU/h	9,000	12,000	18,000
Min~Max Cooling BTU/h	3,100~12,000	3,100~13,600	3,100~20,100
Nominal Heating BTU/h	12,000	16,000	21,600
Min~Max Heating BTU/h	3,100~18,000	3,100~19,400	3,100~25,600
HSPF	13.0	12.2	11.5
SEER	24.0	21.9	20.1
EER Clg	14.5	12.8	11.2
Cooling Operating Range °F(°C)	14~115 (-10~46)	14~115 (-10~46)	14~115 (-10~46)
Heating Operating Range °F(°C)	-5~75 (-21~24)	-5~75 (-21~24)	-5~75 (-21~24)
Moisture Removal Pt./h(l/h)	1.3 (.06)	2.5 (1.2)	4.6 (2.2)
Voltage/Frequency/Phase	208-230/60/1	208-230/60/1	208-230/60/1
MAX.CRT.BKR (A)	15	15	20
Air Circ. C.F.M. (m ³ /h): Hi	318 (540)	359 (610)	400 (680) Clg
Medium	288 (490)	312 (530)	341 (580) Clg
Low	259 (440)	277 (470)	288 (490) Clg
Quiet	230 (390)	241 (410)	241 (410) Clg
Noise Level dB(A) Clg/Htg: Hi	33/34	37/37	40/44
Medium	32/32	33/33	36/40
Low	29/29	31/31	32/36
Quiet	28/27	28/28	28/30
Outdoor Noise Level Clg/Htg	48/49	49/50	54/55
Running Current Rated (A): Cooling	3.0	4.4	7.1
Heating	4.1	6.7	7.7
Power Use Rated/Max (kW): Clg	0.62/1.40	0.94/1.45	1.61/2.15
Heating	0.89/1.80	1.44/2.00	1.76/2.60
Fan Speeds Stage	4+auto	4+auto	4+auto
Air Direction: Vertical	Automatic	Automatic	Automatic
Air Filter	Washable	Washable	Washable
Front Grille	UTG-CCGF*	UTG-CCGF*	UTG-CCGF*
Connection Method	Flare	Flare	Flare
Conn. Pipe Diameter Inch	suc 3/8 dis 1/4	suc 3/8 dis 1/4	suc 1/2 dis 1/4
Combined Min. Length Ft (m)	10 (3)	10 (3)	10 (3)
Combined Max. Length Ft (m)	66 (20) (pre-charge: 49')	66 (20) (pre-charge: 49')	66 (20) (pre-charge: 49')
Max. Vertical Diff. Ft (m)	49 (15)	49 (15)	49 (15)
Indoor Unit Net Weight lbs. (kg)	33 (15)	33 (15)	33 (15)
Outdoor Unit Net Weight lbs. (kg)	84 (38)	84 (38)	86 (39)
Indoor Unit Dim: Height Inch (mm)	9-11/16 (245)	9-11/16 (245)	9-11/16 (245)
Width Inch (mm)	22-7/16 (570)	22-7/16 (570)	22-7/16 (570)
Depth Inch (mm)	22-7/16 (570)	22-7/16 (570)	22-7/16 (570)
Grille Dim: Height Inch (mm)	1-15/16 (49)	1-15/16 (49)	1-15/16 (49)
Width Inch (mm)	27-9/16 (700)	27-9/16 (700)	27-9/16 (700)
Depth Inch (mm)	27-9/16 (700)	27-9/16 (700)	27-9/16 (700)
Outdoor Unit Dim: Height Inch (mm)	24-1/2 (620)	24-1/2 (620)	24-1/2 (620)
Width Inch (mm)	31-3/32 (790)	31-3/32 (790)	31-3/32 (790)
Depth Inch (mm)	11-11/32 (290)	11-11/32 (290)	11-11/32 (290)
Refrigerant	R410A	R410A	R410A

* Compact Cassette Grille UTG-CCGF sold separately. Must order one with each compact cassette.

Note: Figures are based on 230 Volts.

Ceiling Cassette Systems

SYSTEMS 18RCLX, 24RCLX, 36RCLX, 42RCLX



Up to 16.0 SEER

Function

Up to 16-SEER, these models provide up to 30% increase in efficiency over 13-SEER models. These models offer the ability to send up to 38% of their capacity through two branch ducts to adjacent rooms. Slender fit feature now offered on all models decreases space required above the ceiling increasing application opportunities.

Standard Features

- | | |
|-----------------------|--------------------------|
| Weekly Timer | Cold Prevention |
| Dry Mode | Slender Fit |
| Auto Louver: Up/ Down | Remote Temp. Sensor |
| Auto Mode | Daisy Chain |
| Energy Saver | Pump Down Operation |
| Auto Restart/Reset | High Ceiling Mode |
| Auto Changeover | Branch Duct Capable |
| 0°F Ambient Cooling | Built-in Condensate Pump |
| Long Piping Length | Fresh Air Intake* |

Standard Wired Remote

- Weekly timer
- Set on-off time twice a day
- Set different on-off time by day
- Set time in 5 minute intervals
- Control up to 16 indoor units
- Child lock capable
- Remote temperature sensor

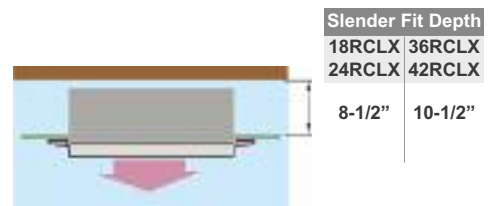
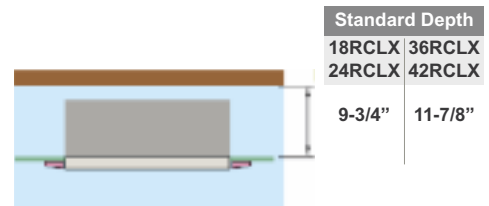

Slender Fit

Cassette body can be moved downward into the room 1-3/8" to accommodate limited ceiling space.

Applications

Four-way airflow, concealed flush mount design and the ability to operate in high ceiling rooms makes these systems ideal for commercial applications such as offices, conference rooms, restaurants, night clubs and bars in retrofit and new construction. Long maximum combined piping lengths of 165 to 230 feet with 60 to 98 feet of height, depending on model, allow the outdoor unit to be remotely located up to 7 stories away and far from indoor unit. The ceiling cassettes are also used in new construction condominiums and homes taking advantage of their branch duct capability to feed adjacent rooms. These heat pumps provide up to 30% additional available heat when compared to conventional models.

*Fresh air knockout available. Fresh air fan and ductwork field supplied. See design and technical manual for details. Fujitsu fresh air intake kit available part #KHRS940-25.



Fujitsu provides knock-outs on all ceiling cassettes where contractors can:

- Install optional field supplied branch ducts on up to two sides to supply up to 18% capacity per side to adjoining spaces up to 16 feet away. See Design and Technical Manual for details.
- Allows fresh air to be brought into the indoor unit using fresh air knockout.

	18RCLX		24RCLX		36RCLX		42RCLX	
	Heat Pump		Heat Pump		Heat Pump		Heat Pump	
Nominal Cooling BTU/h	17,800		22,200		34,100		42,700	
Min.~Max. Cooling BTU/h	5,000~21,500		5,000~27,300		8,500~36,000		13,700~45,000	
Nominal Heating BTU/h	21,000		24,200		36,000		45,200	
Low Temp. Heating 17°F BTU/h	11,300		14,600		23,000		28,200	
Min.~Max. Heating BTU/h	5,000~25,600		5,000~29,000		9,200~42,700		14,300~54,600	
HSPF BTU/hW	8.5		8.5		8.5		8.5	
SEER BTU/hW	16.0		15.0		14.0		15.0	
EER Clg	11.1		10.6		8.1		9.2	
Clg. Operating Range °F(°C)	0~115 (-18~46)		0~115 (-18~46)		0~115 (-18~46)		0~115 (-18~46)	
Htg. Operating Range °F(°C)	14~75 (-10~24)		14~75 (-10~24)		14~75 (-10~24)		0~75 (-18~24)	
Moisture Removal Pt./h(l/h)	5.3 (2.5)		6.4 (3.0)		8.5 (4.0)		11.6 (5.5)	
Voltage/Frequency/Phase	208-230/60/1		208-230/60/1		208-230/60/1		208-230/60/1	
MAX.CRT.BKR (A)	20		20		30		30	
Air Circ. C.F.M. (m ³ /h): Hi	559 (950)		618 (1,050)		942 (1,600)		1,000 (1,700)	
Medium	477 (810)		536 (910)		824 (1,400)		854 (1,450)	
Low	394 (670)		436 (740)		677 (1,150)		736 (1,250)	
Noise Level dB(A): Hi	42/40 (Clg/Htg)		45/43 (Clg/Htg)		48/48 (Clg/Htg)		50/50 (Clg/Htg)	
Medium	39/38 (Clg/Htg)		43/39 (Clg/Htg)		45/45 (Clg/Htg)		48/48 (Clg/Htg)	
Low	36/36 (Clg/Htg)		38/35 (Clg/Htg)		41/41 (Clg/Htg)		44/44 (Clg/Htg)	
Outdoor Noise Level dB(A)	51/53 (Clg/Htg)		53/55 (Clg/Htg)		54/55 (Clg/Htg)		55/56 (Clg/Htg)	
Current Rated/Max (A): Cooling	7.0/12.5		9.2/12.5		18.3/18.8		20.3/21.7	
Heating	8.9/12.5		10.4/12.5		16.1/18.8		18.8/21.7	
Power Use Rated/Max (kw): Clg	1.61/2.88		2.10/2.88		4.22/4.35		4.66/4.99	
Heating	2.05/2.88		2.37/2.88		3.70/4.35		4.31/4.99	
Fan Speeds Stage	3 + Auto		3 + Auto		3 + Auto		3 + Auto	
Air Direction: Horizontal	-		-		-		-	
Vertical	Automatic		Automatic		Automatic		Automatic	
Air Filter	Washable		Washable		Washable		Washable	
Front Grille	Removable		Removable		Removable		Removable	
Connection Method	Flare		Flare		Flare		Flare	
Combined Min. Lgth Ft (m)	16 (5)		16 (5)		16 (5)		16 (5)	
Combined Max. Lgth Ft (m)	165 (50) Each (pre-charge: 49')		165 (50) Each (pre-charge: 49')		165 (50) Each (pre-charge: 49')		230 (70) Each (pre-charge: 66)	
Max. Vertical Diff. Ft (m)	66 (20)		66 (20)		98 (30)		98 (30)	
Conn. Pipe Diameter Inch	Suc. 1/2	Dis. 1/4	Suc. 5/8	Dis. 3/8	Suc. 5/8	Dis. 3/8	Suc. 5/8	Dis. 3/8
Net Weight lbs. (kg)	75 (34)	141 (64)	75 (34)	141 (64)	82 (37)	141 (64)	88 (40)	231 (105)
Dimensions: Height Inch	9-3/4	32-3/4	9-3/4	32-3/4	11-5/8	32-3/4	11-5/8	50-7/8
mm	246	830	246	830	296	830	296	1290
Width Inch	32-3/4	35-1/2	32-3/4	35-1/2	32-3/4	35-1/2	32-3/4	35-1/2
mm	830	900	830	900	830	900	830	900
Depth Inch	32-3/4	13	32-3/4	13	32-3/4	13	32-3/4	13
mm	830	330	830	330	830	330	830	330
Refrigerant	R410A		R410A		R410A		R410A	
	Indoor AUU18RCLX	Outdoor AOU18RLX	Indoor AUU24RCLX	Outdoor AOU24RLX	Indoor AUU36RCLX	Outdoor AOU36RLX	Indoor AUU42RCLX	Outdoor AOU42RLX



Note: Figures are based on 230 Volts.

MULTI ZONE MINI-SPLIT SYSTEMS

- Operate as few as one indoor unit or all indoor units
- Choose from 4 indoor unit styles - wall mount, slim duct, compact cassette, and floor mount
- Eight combinations are ENERGY STAR® qualified
- Create over thousands of combinations based on indoor type and BTU



- Connect 2 to 5 indoor units, depending on model
- Connect 14,000 to 54,000 BTU
- No branch boxes or separation tubes required



18, 24, 36,000 BTUs

- Connect 2 to 4 indoor units, depending on model
- Connect 14,000 to 39,000 BTU
- eXtra Low Temp Heating down to -15°F outdoor temps
- No branch boxes or separation tubes required



- Connect 2 to 8 indoor units
- 80 to 130% connectable capacity
- Connect 39,000 to 62,000 BTU
- Branch boxes and separation tubes required



Year-Round, Whole Home or Business Comfort

Halcyon Systems are some of today's most advanced forms of heating and air conditioning. Multi-zone outdoor units can operate from 2 to 8 indoor units simultaneously. Fujitsu's systems are super quiet as well as highly energy efficient.

Shown to the right is outdoor model AOU36RLXFZ1 connected to a compact cassette, slim duct and wall mount indoor units.



Multi-Zone and XLTH Series Systems 18, 24, 36, and 45,000 BTU/h

AOU18RLXFZ, AOU18RLXFZH, AOU24RLXFZ, AOU24RLXFZH, AOU36RLXFZ1, AOU36RLXFZH, AOU45RLXFZ

Connectable Capacity

This function allows you to connect indoor units that can exceed outdoor unit capacity. However, if you connect indoor units that exceed 100% of the outdoor unit's capacity there are limitations.

If all indoor units are cooling or heating at the same time, the system will limit their capacity so that their total matches the outdoor unit's capacity. When a zone meets a desired set temperature it requires less capacity. The unused capacity is then distributed to the remaining indoor units, increasing their capacity.

For Example

The load on a 3-bedroom home with a living room and kitchen downstairs and 3 bedrooms upstairs is 39,000 BTUs (21,000 BTU downstairs and 18,000 BTU upstairs). However the family isn't upstairs and downstairs at the same time, therefore not all units will be running simultaneously allowing 100% heating or cooling to occupied spaces. This can be achieved by our AOU36RLXFZ1 outdoor unit.

HFI Series System 48,000 BTU/h

AOU48RLXFZ1

130% Connectable Capacity

The HFI system is rated at 48,000 BTUs but you can connect up to 130%, or 62,000 BTUs of rated indoor unit capacity to the AOU48RLXFZ1. Connectable capacity allows you to connect indoor units that can exceed outdoor unit capacity. However, if you connect indoor units that exceed 100% of the outdoor unit's capacity there are limitations.

If all indoor units are cooling or heating at the same time, the system will limit their capacity so that their total matches the outdoor unit's capacity. When a zone meets a desired set temperature it requires less capacity. The unused capacity is then distributed to the remaining indoor units, increasing their capacity.

For Example

The load on a small 2-story office building with a business downstairs and worker apartments upstairs is 62,000 BTUs (38,000 BTUs downstairs and 24,000 BTUs upstairs) but the workers aren't upstairs and downstairs at the same time, therefore not all units will be running simultaneously allowing 100% heating or cooling to occupied spaces.

Mix and Match Flexibility

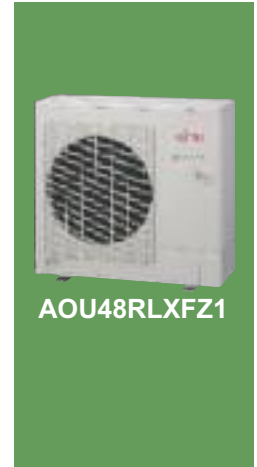

Wall Mounts

The ability to create the right combinations, the right quantity (up to 8-zones), the right style indoor units, and the right capacity.

It's the RIGHT choice for your home or business.



ASU7, 9, 12RLF1



ASU15RLS2*
 *

* ASU15RLS2 is NOT compatible with AOU18/24/36RLXFZH, AOU36RLXFZ1 or AOU45RLXFZ.



ASU18RLF



ASU24RLF

Slim Ducts



ARU7, 9, 12RLF



ARU18RLF



ARU24RLF

Floor Mounts



AGU9, 12RLF



AGU15RLF

Separation Tubes, Branch Boxes

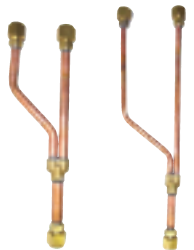

UTP-SX248A



UTP-PU03A, UTP-PU03B

Compact Cassettes



AUU7, 9, 12RLF



AUU18RLF

Individual Zoning: Personalized Whole Home Comfort

Wall Mounted

They mount high on a wall, out of sight and do not require ductwork, increasing energy efficiency.

- Quiet operation
- Easy maintenance
- High delivered efficiency means lower utility bills



Slim Duct

Mounted in a ceiling or in a framed enclosure below a ceiling. They use minimal ductwork and remain very energy efficient.

- Concealed and out of sight
- Look of central air with the efficiency of a mini-split
- Less ducts = higher efficiency

Compact Cassette

Cassettes are extremely discreet, with only the grille showing in the ceiling. They use the latest fan technology to distribute the conditioned air evenly.

- Wired remote control (wireless is optional)
- Powerful turbo fan operation
- Fits into a standard 2' x 2' ceiling grid



Floor Mounted

Floor mount systems are ideal for residential radiator replacements or any room with limited upper wall space, like a kitchen or sunroom.

- Compact size fits easily under a standard window
- Features twin airflow for improved heat delivery
- Designer wireless remote control

Wall Mounted 7, 9, 12, 15, 18 and 24,000 BTUs

ASU7RLF1, ASU9RLF1, ASU12RLF1, ASU15RLS2, ASU18RLF, ASU24RLF



ASU7, 9, 12RLF1



ASU18, 24RLF



ASU15RLS2+

						Designer Series**
	ASU7RLF1 Heat Pump	ASU9RLF1 Heat Pump	ASU12RLF1 Heat Pump	ASU18RLF Heat Pump	ASU24RLF Heat Pump	ASU15RLS2 Heat Pump**
Nominal Cooling BTU/h	7,000	9,000	12,000	18,000	24,000	14,000
Nominal Heating BTU/h	8,100	10,200	13,500	20,000	27,000	16,300
Voltage/Frequency/Phase	208-230/60/1	208-230/60/1	208-230/60/1	208-230/60/1	208-230/60/1	208-230/60/1
Air Circ. C.F.M. (m ³ /h): Hi	Clg 330 (560) Htg 330 (560)	Clg 353 (600) Htg 353 (600)	Clg 388 (660) Htg 388 (660)	Clg 542 (920) Htg 542 (920)	Clg 659 (1,120) Htg 647 (1,100)	Clg 418 (710) Htg 418 (710)
Medium	Clg 294 (500) Htg 294 (500)	Clg 306 (520) Htg 306 (520)	Clg 330 (560) Htg 330 (560)	Clg 436 (740) Htg 436 (740)	Clg 530 (900) Htg 530 (900)	Clg 377 (640) Htg 377 (640)
Low	Clg 253 (430) Htg 253 (430)	Clg 253 (430) Htg 253 (430)	Clg 265 (450) Htg 277 (470)	Clg 365 (620) Htg 365 (620)	Clg 436 (740) Htg 436 (740)	Clg 336 (570) Htg 347 (590)
Quiet	Clg 182 (310) Htg 194 (330)	Clg 182 (310) Htg 194 (330)	Clg 182 (310) Htg 194 (330)	Clg 324 (550) Htg 324 (550)	Clg 365 (620) Htg 365 (620)	Clg 230 (390) Htg 253 (430)
Noise Level dB(A) (Clg/Htg): Hi	36/36	37/37	40/40	43/44	49/48	41/41
Medium	32/32	33/33	36/36	37/37	42/42	36/36
Low	29/29	29/29	30/31	33/33	37/37	33/34
Quiet	21/22	21/22	21/22	31/31	33/33	25/27
Running Current Rated (A): Cooling	0.13	0.15	0.19	0.32	0.53	0.20
Heating	0.13	0.15	0.19	0.32	0.53	0.20
Power Use Rated (w): Clg	15	17	22	41	69	23
Htg	15	17	22	41	69	23
Fan Speeds Stage	4+auto	4+auto	4+auto	4+auto	4+auto	4+auto
Air Direction: Horizontal	Manual	Manual	Manual	Auto	Auto	Manual
Vertical	Auto	Auto	Auto	Auto	Auto	Auto
Primary Air Filter	Washable	Washable	Washable	Washable	Washable	Washable
Ion Deodorizing Filter	Disposable	Disposable	Disposable	Disposable	Disposable	Disposable
Apple-Catechin Filter	Disposable	Disposable	Disposable	Disposable	Disposable	Disposable
Connection Method	Flare	Flare	Flare	Flare	Flare	Flare
Conn. Pipe Diameter Inch	suc 3/8 dis 1/4	suc 3/8 dis 1/4	suc 3/8 dis 1/4	suc 1/2 dis 1/4	suc 5/8 dis 1/4	suc 1/2 dis 1/4
Net Weight lbs. (kg)	19 (8.5)	19 (8.5)	19 (8.5)	31 (14)	31 (14)	21 (9.5)
Dims: Height Inch (mm)	10-1/2 (268)	10-1/2 (268)	10-1/2 (268)	12-5/8 (320)	12-5/8 (320)	11-1/8 (282) / 13-1/4 [^] (337 [^])
Width Inch (mm)	33-1/16 (840)	33-1/16 (840)	33-1/16 (840)	39-1/4 (998)	39-1/4 (998)	34-1/4 (870)
Depth Inch (mm)	8 (203)	8 (203)	8 (203)	9 (228)	9 (228)	7-1/4 (185)
Refrigerant	R410A	R410A	R410A	R410A	R410A	R410A

* ESP feature not compatible in multi-zone configurations. + ASU15RLS2 is NOT compatible with AOU18/24/36RLXFZH, AOU36RLXFZ1 or AOU45RLXFZ.

[^]Height when front panel is open.

Standard Features

- Wireless Remote Control*
- Apple Catechin Filter
- Ion Deodorizing Filter
- Sleep Timer
- 24-Hour Timer
- Dry Mode
- Auto Louver: 4-Way**
- Auto Mode
- Minimum Heat Mode
- Auto Restart/Reset
- Power Diffuser**

Built In Filtration



Long-life⁺ Ion Deodorization Filter

The filter deodorizes by powerfully decomposing absorbed odors using the oxidizing and reducing effects of ions generated by the ultra-fine-particle ceramic.

+ The filter can be used for approximately 3 years if it is washed with water when dirty to restore its surface action.

* Features vary by model and therefore standard wireless remote controls should be used with the models they are associated with.

** Feature of models ASU18, 24RLF only.



Apple-Catechin Filter

Dust, mold spores and micro-organisms are absorbed onto the filter by static electricity and growth is inhibited and deactivated.

Slim Duct 7, 9, 12, 18 and 24,000 BTUs

ARU7RLF, ARU9RLF, ARU12RLF, ARU18RLF, ARU24RLF

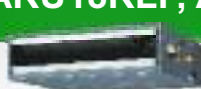

ARU7, 9, 12RLF



ARU18RLF

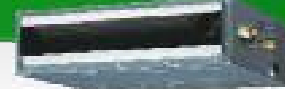

ARU24RLF

Flexible Installation

Horizontal or vertical*.



*Internal drain pump will not operate when the unit is mounted in a vertical configuration.

Slim Duct

Adaptable when ceiling cavity is small and there is no slope for drain.

Traditional



Slim Duct



Nominal Cooling BTU/h	7,000	9,000	12,000	18,000	24,000
Nominal Heating BTU/h	8,100	10,200	13,500	20,000	27,000
Voltage/Frequency/Phase	208-230/60/1	208-230/60/1	208-230/60/1	208-230/60/1	208-230/60/1
Static Pressure In. W. C.	0 ~ 0.36	0 ~ 0.36	0 ~ 0.36	0 ~ 0.36	0 ~ 0.20
Air Circ. C.F.M. (m ³ /h) Clg/Htg: Hi	323 (550)	353 (600)	383 (650)	554 (940)	783 (1,330)
Medium	288 (490)	324 (550)	353 (600)	518 (880)	730 (1,240)
Low	276 (470)	294 (500)	324 (550)	483 (820)	648 (1,100)
Quiet	259 (440)	265 (450)	283 (480)	442 (750)	607 (1,030)
Noise Level dB(A) (Clg/Htg): Hi	28/28	28/28	29/29	32/33	33/35
Medium	26/26	27/26	28/28	31/32	32/34
Low	25/25	26/25	27/27	30/31	30/32
Quiet	24/24	25/24	26/24	29/29	29/29
Running Current Rated (A): Cooling	0.30	0.30	0.35	0.44	0.66
Heating	0.30	0.30	0.35	0.44	0.66
Power Use Rated (W): Cooling	33	49	58	73	111
Heating	33	49	58	73	111
Fan Speeds Stage	4 + Auto	4 + Auto	4 + Auto	4 + Auto	4 + Auto
Air Filter	Washable	Washable	Washable	Washable	Washable
Connection Method	Flare	Flare	Flare	Flare	Flare
Conn. Pipe Diameter Inch	suc 3/8 dis 1/4	suc 3/8 dis 1/4	suc 3/8 dis 1/4	suc 1/2 dis 1/4	suc 5/8 dis 1/4
Net Weight lbs. (kg)	37 (17)	41 (19)	41 (19)	50 (23)	59 (27)
Dimensions: Height Inch (mm)	7-25/32 (198)	7-25/32 (198)	7-25/32 (198)	7-25/32 (198)	7-25/32 (198)
Width Inch (mm)	27-9/16 (700)	27-9/16 (700)	27-9/16 (700)	35-7/16 (900)	43-5/16 (1,100)
Depth Inch (mm)	24-13/32 (620)	24-13/32 (620)	24-13/32 (620)	24-13/32 (620)	24-13/32 (620)
Supply Duct Flange	5-15/16 (151)	5-15/16 (151)	5-15/16 (151)	5-15/16 (151)	5-15/16 (151)
Dimensions: Height Inch (mm)	5-15/16 (151)	5-15/16 (151)	5-15/16 (151)	5-15/16 (151)	5-15/16 (151)
Width Inch (mm)	25-19/32 (650)	25-19/32 (650)	25-19/32 (650)	33-15/32 (850)	41-11/32 (1,050)
Depth Inch (mm)	3/4 (19)	3/4 (19)	3/4 (19)	3/4 (19)	3/4 (19)
Return Duct	6 (152)	6 (152)	6 (152)	6 (152)	6 (152)
Dimensions: Height Inch (mm)	6 (152)	6 (152)	6 (152)	6 (152)	6 (152)
Width Inch (mm)	22 (559)	22 (559)	22 (559)	30 (762)	37-3/4 (959)
Depth Inch (mm)	3/4 (19) (Flat)	3/4 (19) (Flat)	3/4 (19) (Flat)	3/4 (19) (Flat)	3/4 (19) (Flat)
Refrigerant	R410A	R410A	R410A	R410A	R410A

Standard Features

- Dry Mode
- Weekly Timer
- Sleep Timer*
- 24-Hour Timer*
- Minimum Heat Mode*
- Auto Mode
- Quiet Mode
- Auto Restart/Reset
- Auto Changeover
- Condensate Pump
- Fresh Air Intake

*Available only with optional wireless remote control.

Field Supplied Filters

Filters are sized to keep velocities and static pressure loss low. This will insure sufficient static pressure is available for ductwork, fittings and supply and return grilles. Alternative filter sizes with equivalent face areas can be used.

	ARU 7RLF	ARU 9RLF	ARU 12RLF	ARU 18RLF	ARU 24RLF
CFM	323	353	383	554	785
Typical Filter Size	12 x 20	12 x 20	12 x 20	14 x 25	18 x 30
Velocity, FPM	194	212	230	228	209
Unit External SP, in. W.C.	0.36	0.36	0.36	0.36	0.20
1" Fiberglass Filter					
SP Loss, in. W.C.	0.04	0.04	0.05	0.04	0.04
Available Static Pressure	0.32	0.32	0.31	0.32	0.16
1" MERV 8 Pleated Filter					
SP Loss, in. W.C.	0.10	0.12	0.14	0.14	0.12
Available Static Pressure	0.26	0.24	0.22	0.22	0.08
2" MERV 8 Pleated Filter					
SP Loss, in. W.C.	0.06	0.07	0.08	0.08	0.07
Available Static Pressure	0.30	0.29	0.28	0.28	0.13

Compact Cassettes 7, 9, 12, and 18,000 BTUs

AUU7RLF, AUU9RLF, AUU12RLF, AUU18RLF



Easy Installation

Fits into a standard ceiling tile*.

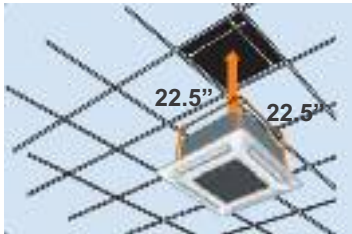

*Dimensions of outer grille are 27-9/16" x 27-9/16" and may overlap adjacent tiles.

2-Stage Turbo Fan

Air distribution is evenly spread across the heat exchanger by the new 2 stage turbo fan which produces two separate airflow streams.

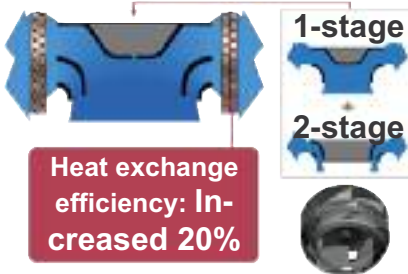

	AUU7RLF	AUU9RLF	AUU12RLF	AUU18RLF
	Heat Pump	Heat Pump	Heat Pump	Heat Pump
Nominal Cooling BTU/h	7,000	9,000	12,000	18,000
Nominal Heating BTU/h	8,100	10,200	13,500	20,000
Voltage/Frequency/Phase	208-230/60/1	208-230/60/1	208-230/60/1	208-230/60/1
Air Circ. C.F.M. (m ³ /h): Hi	318 (540) Clg or Htg	318 (540) Clg or Htg	359 (610) Clg or Htg	441 (750) Clg 471 (800) Htg
Medium	288 (490) Clg or Htg	288 (490) Clg or Htg	312 (530) Clg or Htg	359 (610) Clg 418 (710) Htg
Low	259 (440) Clg or Htg	259 (440) Clg or Htg	277 (470) Clg or Htg	306 (520) Clg 353 (600) Htg
Quiet	230 (390) Clg or Htg	230 (390) Clg or Htg	241 (410) Clg or Htg	241 (410) Clg 265 (450) Htg
Noise Level dB(A) Clg/Htg: Hi	33/34	33/34	37/37	42/44
Medium	31/32	31/32	33/33	37/40
Low	29/29	29/29	31/31	33/37
Quiet	27/27	27/27	28/28	29/30
Running Current Rated (A): Cooling	0.15	0.15	0.19	0.30
Heating	0.15	0.15	0.19	0.30
Power Use Rated/Max (W): Clg	18	18	23	39
Heating	18	18	23	39
Fan Speeds Stage	4+auto	4+auto	4+auto	4+auto
Air Direction: Vertical	Automatic	Automatic	Automatic	Automatic
Air Filter	Washable	Washable	Washable	Washable
Front Grille	UTG-CCGF*	UTG-CCGF*	UTG-CCGF*	UTG-CCGF*
Connection Method	Flare	Flare	Flare	Flare
Conn. Pipe Diameter Inch	suc 3/8 dis 1/4	suc 3/8 dis 1/4	suc 3/8 dis 1/4	suc 1/2 dis 1/4
Net Weight lbs. (kg)	33 (15)	33 (15)	33 (15)	33 (15)
Chassis Dim: Height Inch (mm)	9-11/16 (245)	9-11/16 (245)	9-11/16 (245)	9-11/16 (245)
Width Inch (mm)	22-7/16 (570)	22-7/16 (570)	22-7/16 (570)	22-7/16 (570)
Depth Inch (mm)	22-7/16 (570)	22-7/16 (570)	22-7/16 (570)	22-7/16 (570)
Grille Dim: Height Inch (mm)	1-15/16 (49)	1-15/16 (49)	1-15/16 (49)	1-15/16 (49)
Width Inch (mm)	27-9/16 (700)	27-9/16 (700)	27-9/16 (700)	27-9/16 (700)
Depth Inch (mm)	27-9/16 (700)	27-9/16 (700)	27-9/16 (700)	27-9/16 (700)
Refrigerant	R410A	R410A	R410A	R410A

Standard Features

- Sleep Timer
- Dry Mode
- Auto Louver: Up/ Down
- Quiet Mode
- Auto Restart/Reset
- Auto Changeover
- Remote Temperature Sensor
- High Ceiling Mode
- Condensate Pump
- 2-Stage Turbo Fan
- Minimum Heat Mode+
- Fresh Air Intake**

+ Available only with optional wireless remote control.

**Requires Fujitsu's Optional Fresh Air Kit part #UTZ-VXAA. Allows for a 4-inch flex duct connection and a field supplied duct booster fan. Fresh air maximum is 10% of unit High fan CFM. See UTZ-VXAA Design and Technical Manual for fan static pressure requirements at Fresh Air Kit. Add hood, filter and duct losses for fan total static pressure requirements. Will add 4" to the height of the indoor unit.

* Compact Cassette Grille UTG-CCGF sold separately. Must order one with each compact cassette.



Fresh Air Kit** UTZ-VXAA

Mixes room air then passes through the heat exchanger.



*Applies when properly registered AND installed by a Fujitsu Elite Contractor in a residence. See full warranty for details.

Floor Mount 9, 12, and 15,000 BTUs

AGU9RLF, AGU12RLF, AGU15RLF



2-Fan and Wide Airflow

Having both upper and lower airflow quickly warms or cools the entire room. Floor mount can be set in "Upward Airflow Only" when occupants wish not to have feet warmed or cooled.

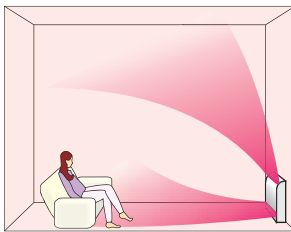

Flexible and Easy Installation

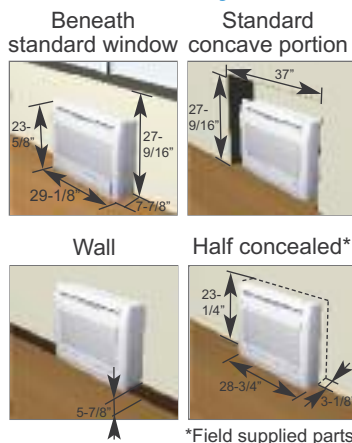

*Field supplied parts required

Standard Features

- Wireless Remote Control
- Apple Catechin Filter
- Ion Deoderizing Filter
- Sleep Timer
- 24-Hour Timer
- Auto Louver: Up/Down
- Auto Mode
- Minimum Heat Mode
- Economy Mode
- Auto Restart/Reset
- Auto Changeover
- Powerful Mode



Designer wireless remote control

	AGU9RLF Heat Pump	AGU12RLF Heat Pump	AGU15RLF Heat Pump
Nominal Cooling BTU/h	9,000	12,000	14,200
Nominal Heating BTU/h	12,000	16,000	18,000
Voltage/Frequency/Phase	208-230/60/1	208-230/60/1	208-230/60/1
Air Circ. C.F.M. (m ³ /h): Hi	312 (530)	353 (600)	383 (650)
Medium	259 (440)	288 (490)	306 (520)
Low	212 (360)	224 (380)	235 (400)
Quiet	159 (270)	159 (270)	159 (270)
Noise Level dB(A)Clg/Htg: Hi	39/39	42/42	44/44
Medium	34/34	36/38	38/39
Low	28/28	30/32	31/33
Quiet	22/22	22/22	22/22
Running Current Rated (A): Cooling	0.15	0.18	0.20
Heating	0.15	0.18	0.20
Power Use Rated (W): Cooling	16	18	23
Heating	16	18	23
Fan Speeds Stage	4+Auto	4+Auto	4+Auto
Air Direction: Horizontal	Manual	Manual	Manual
Vertical	Auto	Auto	Auto
Air Filter	Washable	Washable	Washable
Apple Catechin Filter	Yes	Yes	Yes
Ion Deoderizing Filter	Yes	Yes	Yes
Connection Method	Flare	Flare	Flare
Conn. Pipe Diameter Inch	Suc. 3/8 Dis. 1/4	Suc. 3/8 Dis. 1/4	Suc. 1/2 Dis. 1/4
Net Weight lbs. (kg)	31 (14)	31 (14)	31 (14)
Dimensions: Height Inch	23-5/8	23-5/8	23-5/8
mm	600	600	600
Width Inch	29-1/8	29-1/8	29-1/8
mm	740	740	740
Depth Inch	7-7/8	7-7/8	7-7/8
mm	200	200	200
Refrigerant	R410A	R410A	R410A



*Applies when properly registered AND installed by a Fujitsu Elite Contractor in a residence. See full warranty for details.

Multi-Zone Series

AOU18RLXFZ, AOU24RLXFZ, AOU36RLXFZ1,
AOU45RLXFZ



Contractors can select either an 18, 24, 36 or 45,000 BTU outdoor unit combined with wall mounted, slim duct, compact cassette or floor mount type indoor units. Mix-and-match flexibility of evaporator type and capacity allows you to choose the indoor unit that best fits the application, whether it be hidden or showcased. These systems are ideal for nursing homes, doctor's offices, condominiums, apartments and residences - any place where individual cooling or heating is needed.

- Connect 2 to 5 indoor units, depending on model
- Connect 14,000 to 54,000 BTU
- Energy efficient - up to 19.7 SEER and 10.3 HSPF
- No branch boxes or separation tubes

Fujitsu Multi-Zones Make Sense

- **Why Choose an 18,000 BTU Zoned System?**
A lower BTU dual zone is often the perfect solution to a comfort need. A consumer shouldn't have to purchase a higher priced larger unit when only 14 to 18,000 BTU's are needed.
- **A Tri-Zone 24,000 BTU Unit**
Fujitsu offers a 2-ton system that provides 2 or 3-zone flexibility. By using connectable capacity, this system allows up to three 9,000 BTU units.
- **Pricing Compared to Competition**
Additional outdoor units provides better matched BTU capacity with indoor units. By better matching the outdoor unit to the indoor capacity a better system value is achieved.



Multi Zone Outdoor Units 18, 24, 36 and 45,000 BTUs

**AOU18RLXFZ, AOU24RLXFZ,
AOU36RLXFZ1, AOU45RLXFZ**



AOU36RLXFZ1

AOU45RLXFZ

AOU18, 24RLXFZ

AOU 18RLXFZ	AOU 24RLXFZ	AOU 36RLXFZ1	AOU 45RLXFZ
Heat Pump ASU9+ASU9	Heat Pump ASU9+ASU7+ASU7	Heat Pump ASU9 x 4	Heat Pump ASU9 x 5
2	2 to 3	3 to 4	2 to 5
14 to 21,000 ¹	14 to 27,000 ¹	27 to 39,000 ¹	34 to 54,000
18,000/22,000	22,000/24,000	35,200/36,400	45,000/48,000
Clg. Operating Range °F(°C) 14 to 115 (-10 to 46)	14 to 115 (-10 to 46)	14 to 115 (-10 to 46)	14 to 115 (-10 to 46)
Htg. Operating Range °F(°C) 5 to 75 (-15 to 24)	5 to 75 (-15 to 24)	5 to 75 (-15 to 24)	5 to 75 (-15 to 24)
Input Power: Clg/Htg Rated kW* 1.44/1.87	1.76/1.73	3.52/3.00	4.28/3.88
Voltage/Frequency/Phase 208-230/60/1	208-230/60/1	208-230/60/1	208-230/60/1
Current: Total Max. (A) 10.0	13.7	20.3	23.8
Minimum Circuit Ampacity (A) 12.1	16.7	24.6	28.9
MAX.CRT.BKR (A) 15	20	30	30
Fan: Type x Quantity Propeller x 1	Propeller x 1	Propeller x 1	Propeller x 1
Sound Pressure Level Cooling dB(A) 49	51	53	53
Sound Pressure Level Heating dB(A) 49	52	55	55
Pre-Charge Length Total Ft (m) 98 (30)	98 (30)	164 (50)	164 (50)
Max. Length Total Ft (m) 164 (50)	164 (50)	230 (70)	264 (80)
Max. Length Each Ft (m) 82 (25)	82 (25)	82 (25)	82 (25)
Min. Length Total Ft (m) 49 (15)	49 (15)	66 (20)	49 (15)
Min. Length Each Ft (m) 16 (5)	16 (5)	16 (5)	16 (5)
Max. Pipe Height Difference Between Outdoor Unit & Farthest Indoor Ft (m) 49 (15)	49 (15)	49 (15)	49 (15)
Max. Pipe Height Difference Between Indoor Units Ft (m) 33 (10)	33 (10)	33 (10)	33 (10)
Connection Method Flare	Flare	Flare	Flare
Conn. Pipe Diameter Inch Liq. 1/4 x 2 Suc. 3/8 x 2	Liq. 1/4 x 3 Suc. 1/2 x 1, 3/8 x 2	Liq. 1/4 x 4 Suc. 1/2 x 1, 3/8 x 3	Liq. 1/4 x 5 Suc. 1/2 x 2, 3/8 x 3
Net Weight lbs. (kg) 119 (54)	124 (56)	149 (68)	205 (93)
Dimensions: Height Inch 27-9/16	27-9/16	32-11/16	39-5/16
mm 700	700	830	998
Width Inch 35-7/16	35-7/16	35-7/16	38-3/16
mm 900	900	900	970
Depth Inch 13	13	13	14-9/16
mm 330	330	330	370
Refrigerant R410A	R410A	R410A	R410A

¹See table for allowed combinations within this connectable capacity range.

Compact Size

The compact size of the outdoor units allows for many installation opportunities.

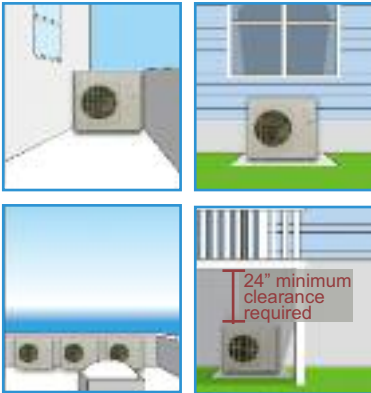

DC Twin Rotary Compressor

A high performance, low noise, large capacity DC twin rotary compressor is used.



Nominal Capacities, SEER and HSPF Ratings

Data below is based on AHRI 210/240 non-ducted wall mounted models.

Model	Indoor Unit		Cooling Capacity Btu/h	EER	SEER	Heating Rated Capacity Btu/h		Heating Maximum Capacity Btu/h		COP	HSPF
	Type	Combination				95 F	47 F	17 F	17 F		
AOU18RLXFZ	Non-Ducted	9+9	18,000	12.5	18.0	22,000	13,900	16,300	13,900	3.44	9.3
	Ducted	9+9	18,000	12.1	16.0	22,000	13,900	16,300	13,900	3.52	9.0
	Mixed	9+9	18,000	12.3	17.0	22,000	13,900	16,300	13,900	3.48	9.2
	Specific	ASU7+ASU12 and ASU9+ASU12	18,000	12.5	18.0	22,000	13,900	16,300	13,900	3.67	9.0
AOU24RLXFZ	Non-Ducted	9+7+7	22,000	12.5	18.0	24,000	14,100	19,800	16,300	4.04	9.5
	Ducted	9+7+7	22,000	10.6	15.5	24,000	14,100	19,800	16,300	3.42	9.0
	Mixed	9+7+7	22,000	11.6	16.8	24,000	14,100	19,800	16,300	3.74	9.3
AOU36RLXFZ1	Non-Ducted	9+9+9+9	35,200	10.0	18.0	24,000	22,000	32,500	25,400	3.56	9.4
	Ducted	9+9+9+9	35,200	9.0	16.0	24,000	22,000	32,500	25,400	3.32	8.7
	Mixed	9+9+9+9	35,200	9.5	17.0	24,000	22,000	32,500	25,400	3.44	9.1
AOU45RLXFZ	Non-Ducted	9+9+9+9+9	45,000	10.5	19.7	48,000	28,200	36,900	31,500	3.60	10.3
	Ducted	9+9+9+9+9	45,000	9.8	17.7	46,000	27,800	36,900	31,500	3.46	9.3
	Mixed	9+9+9+9+9	45,000	10.2	18.7	47,000	28,000	36,900	31,500	3.53	9.8

Yellow rows represent models that are ENERGY STAR® qualified.

Extra Low Temperature Heating Series (XLTH)

AOU18RLXFZH, AOU24RLXFZH, AOU36RLXFZH



18, 24, or 36,000 BTUs

When the temperature drops you don't want to be left in the cold. It's important to choose a heat pump system rated for the climate you live in. If your system doesn't operate in severe conditions you and your family could be left without any heat at all.

Fujitsu's line of mini-split heat pumps come in different sizes, styles, and rated outdoor temperatures. The XLTH Series features outdoor condensing units engineered to operate in temperatures down to -15°F, lower than any other mini-split available today.

- Connect 2 to 4 indoor units, depending on model
- Connect 14,000 to 39,000 BTU
- eXtra Low Temp Heating down to -15°F outdoor temperatures
- Energy efficient - up to 21.5 SEER and 10.3 HSPF
- No branch boxes or separation tubes

The XLTH Difference



Drain hole is not filled, no freezing of base **Freezing where there is no heater**

Condition: Indoor temp. of 68°FDB / outdoor temp. of 5°FDB, Heating mode, High airflow volume. Operation for 24 hours.



XLTH Outdoor Units 18, 24, or 36,000 BTUs

**AOU18RLXFZH, AOU24RLXFZH,
AOU36RLXFZH**



18, 24, or 36,000 BTUs



Ambient Heating Temperature of -15°F

Other models may go as low as -5°F, however they do not include a base heater and other advancements found in XLTH models.

The base of Fujitsu's XLTH outdoor condensing units.



Base Heater

When temperatures reach 36°F, a built-in heater warms the base of the outdoor unit so that condensation doesn't freeze. Without a heater, freezing condensate can cause noise, damage to the fan blade, condenser, and system performance.

Base Drainage Holes

The cultivated base design discharges melted water through many holes located at the bottom of the unit.

Improved Heating Capacity

Heating capacity at low outdoor temperatures was improved by adopting a large heat exchanger and a high capacity compressor.

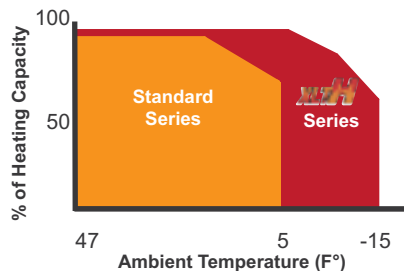

	AOU 18RLXFZH Heat Pump	AOU 24RLXFZH Heat Pump	AOU 36RLXFZH Heat Pump
Connectable Indoor Unit Number	2	2 to 3	2 to 4
Connectable Unit Capacity Class BTU/h	14,000 to 21,000	14,000 to 27,000	27,000 to 39,000
Rated Capacity Cooling/Heating BTU/h	18,000/22,000	22,000/25,000	35,200/36,400
Clg. Operating Range °F(°C)	14 to 115 (-10 to 46)	14 to 115 (-10 to 46)	14 to 115 (-10 to 46)
Htg. Operating Range °F(°C)	-15 to 75 (-26 to 24)	-15 to 75 (-26 to 24)	-15 to 75 (-26 to 24)
Input Power: Clg/Htg Rated kW*	1.33/1.70	1.65/1.81	2.70/2.67
Voltage/Frequency/Phase	208-230/60/1	208-230/60/1	208-230/60/1
Current: Total Max. (A)	16.4	20.8	26.0
Minimum Circuit Ampacity (A)	19.7	25.1	31.5
MAX.CRT.BKR (A)	20	30	40
Fan: Type x Quantity	Propeller x 1	Propeller x 1	Propeller x 1
Sound Pressure Level Cooling dB(A)	48	50	53
Sound Pressure Level Heating dB(A)	50	52	55
Pre-Charge Length Total Ft (m)	98 (30)	98 (30)	164 (50)
Max. Length Total Ft (m)	164 (50)	230 (70)	230 (70)
Max. Length Each Ft (m)	82 (25)	82 (25)	82 (25)
Min. Length Total Ft (m)	49 (15)	49 (15)	49 (15)
Min. Length Each Ft (m)	16 (5)	16 (5)	16 (5)
Max. Pipe Height Difference Between Outdoor Unit & Farthest Indoor Ft (m)	49 (15)	49 (15)	49 (15)
Max. Pipe Height Difference Between Indoor Units Ft (m)	33 (10)	33 (10)	33 (10)
Connection Method	Flare	Flare	Flare
Conn. Pipe Diameter Inch	Liq. 1/4 x 2 Suc. 3/8 x 2	Liq. 1/4 x 3 Suc. 1/2 x 1, 3/8 x 2	Liq. 1/4 x 4 Suc. 1/2 x 1, 3/8 x 3
Net Weight lbs. (kg)	134 (61)	146 (66)	205 (93)
Dimensions: Height Inch	32-11/16	32-11/16	39-5/16
mm	830	830	998
Width Inch	35-7/16	35-7/16	38-3/16
mm	900	900	970
Depth Inch	13	13	14-9/16
mm	330	330	370
Refrigerant	R410A	R410A	R410A

Nominal Capacities, SEER and HSPF Ratings

Data below is based on AHRI 210/240 non-ducted wall mounted models.

Model	Indoor Unit		Cooling Capacity Btu/h	EER	SEER	Heating Rated Capacity Btu/h		Heating Maximum Capacity Btu/h		COP	HSPF
	Type	Combination				95 F	47 F	17 F	17 F		
AOU18RLXFZH	Non-Ducted	9+9	18,000	13.5	21.5	22,000	14,200	23,600	22,000	3.79	10.3
	Ducted	9+9	18,000	12.4	19.0	22,000	14,200	23,600	22,000	3.60	9.0
	Mixed	9+9	18,000	13.0	20.3	22,000	14,200	23,600	22,000	3.70	9.7
AOU24RLXFZH	Non-Ducted	9+7+7	22,000	13.3	20.0	25,000	15,400	26,400	25,000	4.04	10.3
	Ducted	9+7+7	22,000	12.1	18.0	25,000	15,400	26,400	25,000	3.87	9.0
	Mixed	9+7+7	22,000	12.7	19.0	25,000	15,400	26,400	25,000	3.96	9.7
AOU36RLXFZH	Non-Ducted	9+9+9+9	35,200	13.0	20.0	36,400	21,400	39,300	36,400	4.00	10.3
	Ducted	9+9+9+9	35,200	12.0	18.0	36,400	21,400	39,300	36,400	3.88	9.3
	Mixed	9+9+9+9	35,200	12.5	19.0	36,400	21,400	39,300	36,400	3.93	9.8

Yellow rows represent models that are ENERGY STAR® qualified.

Hybrid Flex Inverter Series (HFI)

AOU48RLXFZ1



A **Hybrid** system is the blending of a complex VRF system with the simplicity of a multi-zone system to create a hybrid solution that shares the best of both systems.

Flex provides the ability to create the right combinations, the right quantity (up to 8-zones), the right style indoor units, and the right capacity. It's the right choice for your home or business.

An **Inverter** is a system that controls the rotational speed (not just an ON/OFF signal) of an electric motor by adjusting the frequency and voltage of the electrical power supplied to the motor. The inverter constantly regulates the compressor speed to its optimum energy usage, producing higher refrigerant performance with less power consumption.

This system provides individual temperature control throughout your home or business so each room, zone or floor will be the temperature you set! An optional Central Remote Control is available which can control up to all 8 indoor units from one keypad.

- Connect 2 to 8 indoor units
- 80 to 130% connectable capacity
- Connect 39,000 to 62,000 BTU
- Branch boxes and separation tubes are **REQUIRED**

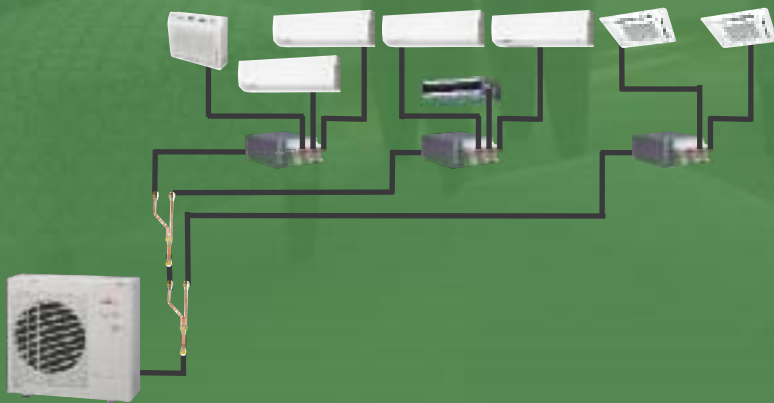

Flex Zone Outdoor Unit 48,000 BTUs

AOU48RLXFZ1



- Connect 2 to 8 indoor units
- 80 to 130% connectable capacity
- Connect 39,000 to 62,000 BTU

2 Indoor Units

18k BTU/h + 24 k BTU/h = 42k BTU/h ··OK
12k BTU/h + 24 k BTU/h = 36k BTU/h ··Not Allowed (below 80%)

8 Indoor Units

7k BTU/h × 8 units = 56k BTU ··OK
9k BTU/h × 8 units = 72k BTU ··Not Allowed (over 130%)

Compact Size

The compact size of outdoor unit AOU48RLXFZ1 allows for many installation opportunities.



Self Diagnostic Feature

This printed circuit board provides three modes of diagnostics - setting, monitoring and function mode, as well as error codes. It also provides a pre-commissioning check function. Setting mode allows optional functions to be selected. Monitoring mode provides temperature for each thermistor, compressor operation and other functions. Function mode provides cooling test run, heating test run and pump down operation.



Piping Flexibility

Contractors can choose the best direction for piping from the outdoor unit.



DC Twin Rotary Compressor

A high performance, low noise, large capacity DC twin rotary compressor is used. Includes Quiet Mode for night operation.



AOU48RLXFZ1 Heat Pump

Connectable Indoor Unit Number	2 to 8
Connectable Indoor Unit Capacity	80 to 130% Nominal (39,000 - 62,000 BTU)
Connectable Branch Box Number	1 to 3
Nominal Cooling BTU/h	48,000
Max Cooling BTU/h	51,100
Nominal Heating BTU/h	54,000
Low Temp. Heating 17°F BTU/h	40,000
Max Heating BTU/h	57,000
Clg. Operating Range °F(°C)	23-115 (-5-46)
Htg. Operating Range °F(°C)	5-75 (-15-24)
Input Power: Cooling Rated kW*	5.52 / 5.19 / 5.35
Input Power: Heating Rated kW*	5.02 / 4.89 / 4.96
Voltage/Frequency/Phase	208-230/60/1
Current: Clg Outdoor Max. (A)	24.5 / 23.0 / 23.7
Current: Htg Outdoor Max. (A)	22.3 / 21.7 / 22.0
MAX.CRT.BKR (A)	40
Fan: Type x Quantity	Propeller x 1
Fan Motor Output W	111
Sound Pressure Level Cooling dB(A)	56
Sound Pressure Level Heating dB(A)	58
Max. Pipe Length Total Ft (m)	377 (115)
Max. Pipe Length Between Box & Farthest Indoor Unit Ft (m)	49 (15)
Max. Pipe Height Difference Between Outdoor Unit & Branch Box Ft (m)	98 (30)
Max. Pipe Height Difference Between Indoor Units Ft (m)	49 (15)
Max. Pipe Height Difference Between Outdoor Unit & Farthest Indoor Ft (m)	98 (30)
Connection Method	Flare
Conn. Pipe Diameter Inch	3/8 (Liq.) 5/8 (Suc.)
Net Weight lbs. (kg)	216 (98)
Dimensions: Height Inch	36
mm	914
Width Inch	38-1/4
mm	970
Depth Inch	14-5/8
mm	370
Refrigerant	R410A

37*Ducted / Non-Ducted / Mixed

	SEER	HSPF	EER**
Ducted	14.7	9.3	8.7
Non-Ducted	17.0	9.8	9.25
Mixed	15.8	9.5	8.97

**Cooling

Branch Boxes

UTP-PU03A, UTP-PU03B



	UTP-PU03A Primary	UTP-PU03B Secondary
Connectable Indoor Unit	1 ~ 3	1 ~ 3
Max. Combination BTU/h	62,000 Nom.*	62,000 Nom.*
Min. Combination BTU/h	7,000 Nom.*	7,000 Nom.*
Clg. Operating Range °F(°C)	25-115 (-5-46)	25-115 (-5-46)
Htg. Operating Range °F(°C)	5-75 (-15-24)	5-75 (-15-24)
%RH	80 or less	80 or less
Voltage/Frequency/Phase	208-230/60/1	208-230/60/1
Maximum Current Ampacity (A)	15	15
Running Current <i>Rated</i> (A): Cooling	0.050	0.050
Heating	0.050	0.050
Power Use <i>Rated</i> (W): Cooling	10	10
Heating	10	10

Dimensions: Gross (Flare to Flare):

	UTP-PU03A Primary	UTP-PU03B Secondary
Height x Width x Depth <i>Inch</i>	7-5/8 x 33 x 14-5/8	7-5/8 x 33 x 14-5/8
Height x Width x Depth <i>mm</i>	195 x 838 x 370	195 x 838 x 370
Dimensions: Net (Metal Box Only):		
Height x Width x Depth <i>Inch</i>	7-5/8 x 17 x 14-5/8	7-5/8 x 17 x 14-5/8
Height x Width x Depth <i>mm</i>	195 x 433 x 370	195 x 433 x 370
Net Weight <i>lbs. (kg)</i>	20 (9)	20 (9)
Conn. Pipe Diameter - Main <i>Inch</i>	(3/8 Liq. x 5/8 Suc.)	(3/8 Liq. x 5/8 Suc.)
Conn. Pipe Diameter - Branch <i>Inch</i>	(1/4 Liq. x 1/2 Suc.) 3 pair	(1/4 Liq. x 1/2 Suc.) 3 pair
Connection Method	Flare	Flare
Connection Adapter Included <i>Inch</i>	(1/2MF x 3/8FF) x 3 (1/2MF x 5/8FF) x 3 No adapter needed for 18k BTU	(1/2MF x 3/8FF) x 3 (1/2MF x 5/8FF) x 3 No adapter needed for 18k BTU

*As long as the total system nominal capacity is between 39,000 and 62,000 BTUs.

Warning: Branch boxes are not weather tight enclosures and cannot be mounted outdoors or in damp environments exceeding 80% relative humidity, unless using the Branch Box Outdoor Enclosure, Part #UTP-PX-A.

Allowed Branch Box Mounting Direction

Threaded Rod Mount



By reversing the electrical box position you can orient the inlet and outlet pipes into a left hand or right hand configuration.

Horizontal Wall Mount



By reversing the electrical box position you can orient the inlet and outlet pipes into a left hand or right hand configuration.

Vertical Wall Mount



You cannot reverse the electrical box position when mounting the branch box vertically.

Branch Box Outdoor Enclosure

UTP-PX-A

The Branch Box Outdoor Enclosure is used to mount the indoor style Branch Box outdoors. The Branch Box Outdoor Enclosure is a painted metal cover to match the condensing unit. When Branch Box Outdoor Enclosure is not required, see Installation Manual for indoor mounting instructions.

Allowed Mounting Positions

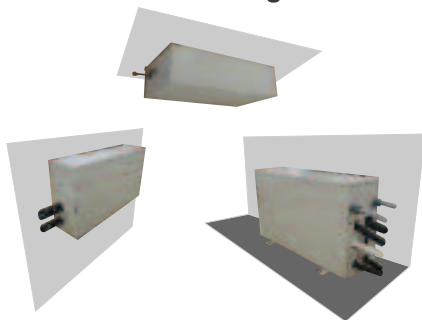

Dimensions in. (mm)	
Net (HxWxD)	8-11/16 x 32 x 17-7/8 (220 x 813 x 454)
Gross (HxWxD)	3-15/16 x 33-11/16 x 20-5/16 (100 x 880 x 515)
Weight lbs. (kg)	
Net Branch Box cover only	22 (10)
Net Branch Box + Cover	44.1(20)
Gross	30.9 (14)



Separation Tube Assembly Kit

UTP-SX248A

Size	Liquid <i>Inch</i>	3/8 x 3/8 x 3/8
	Suction <i>Inch</i>	5/8 x 5/8 x 5/8

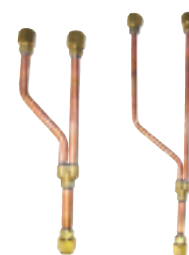

Piping

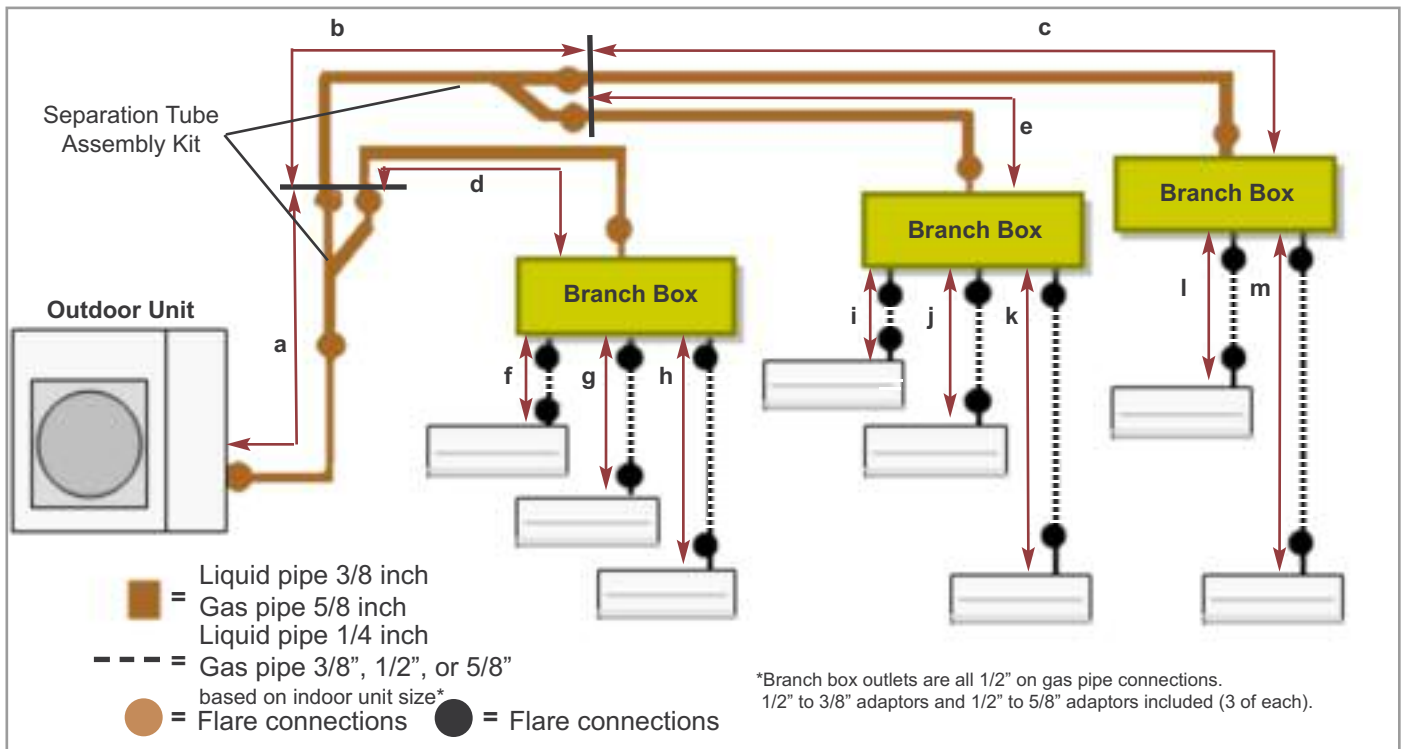

		Liquid pipe	Adaptor	Gas pipe
Branch Box to Indoor	7,000 BTU	1/4 inch	included	3/8 inch
	9,000 BTU		included	
	12,000 BTU		included	
	18,000 BTU		n/a	
	24,000 BTU		included	
Calculate Refrigerant Charge Factory Charge 7.6 lb (3.45 kg) Unit pre-charged to 0 feet	Pipe Diameter	Location		Additional Refrig.
	3/8"	Outdoor to Branch Box		0.624 oz./ft. or 58g/meter
	1/4"	Branch Box to Indoor Unit		0.224 oz./ft. or 21g/meter
(Total length of 3/8" liquid line × 0.624 oz./ft. or 58g/meter) + (Total length of 1/4" liquid line × 0.224 oz./ft. or 21g/meter) + (a+b+c+d+e) × 0.624 oz./ft. or 58g/meter + (f+g+h+i+j+k+l+m) × 0.224 oz./ft. or 21g/meter = additional refrigerant				

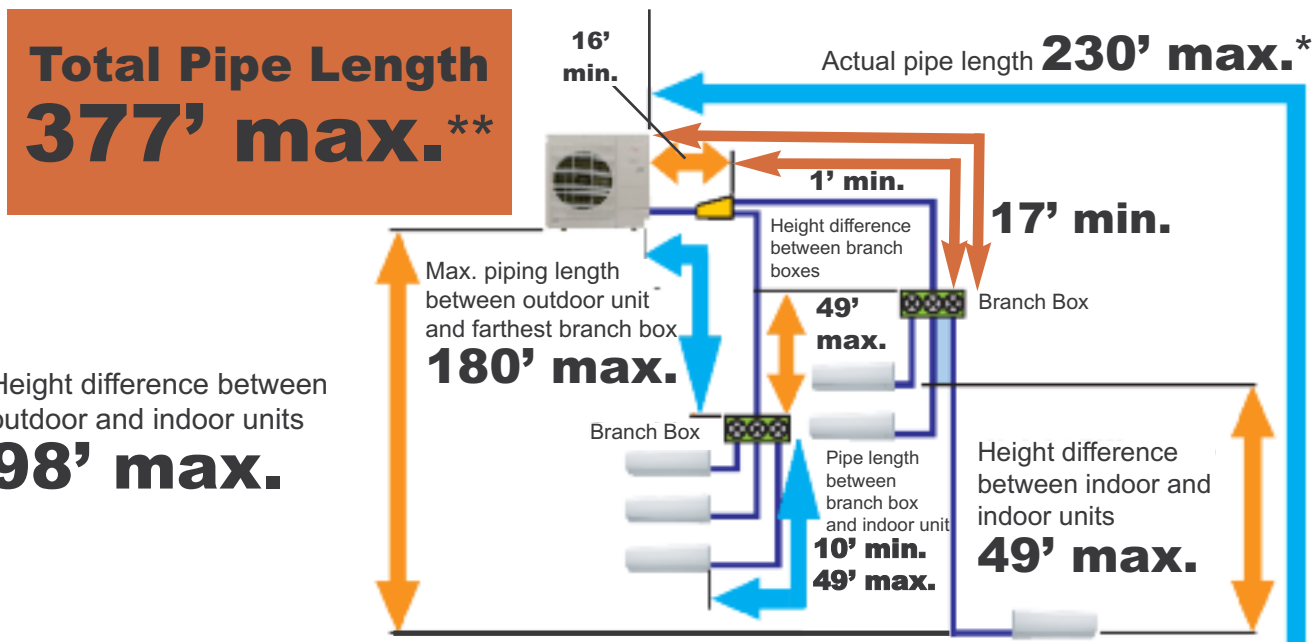

* Distance between outdoor unit & farthest indoor unit.
 ** Total liquid pipe or total gas pipe.

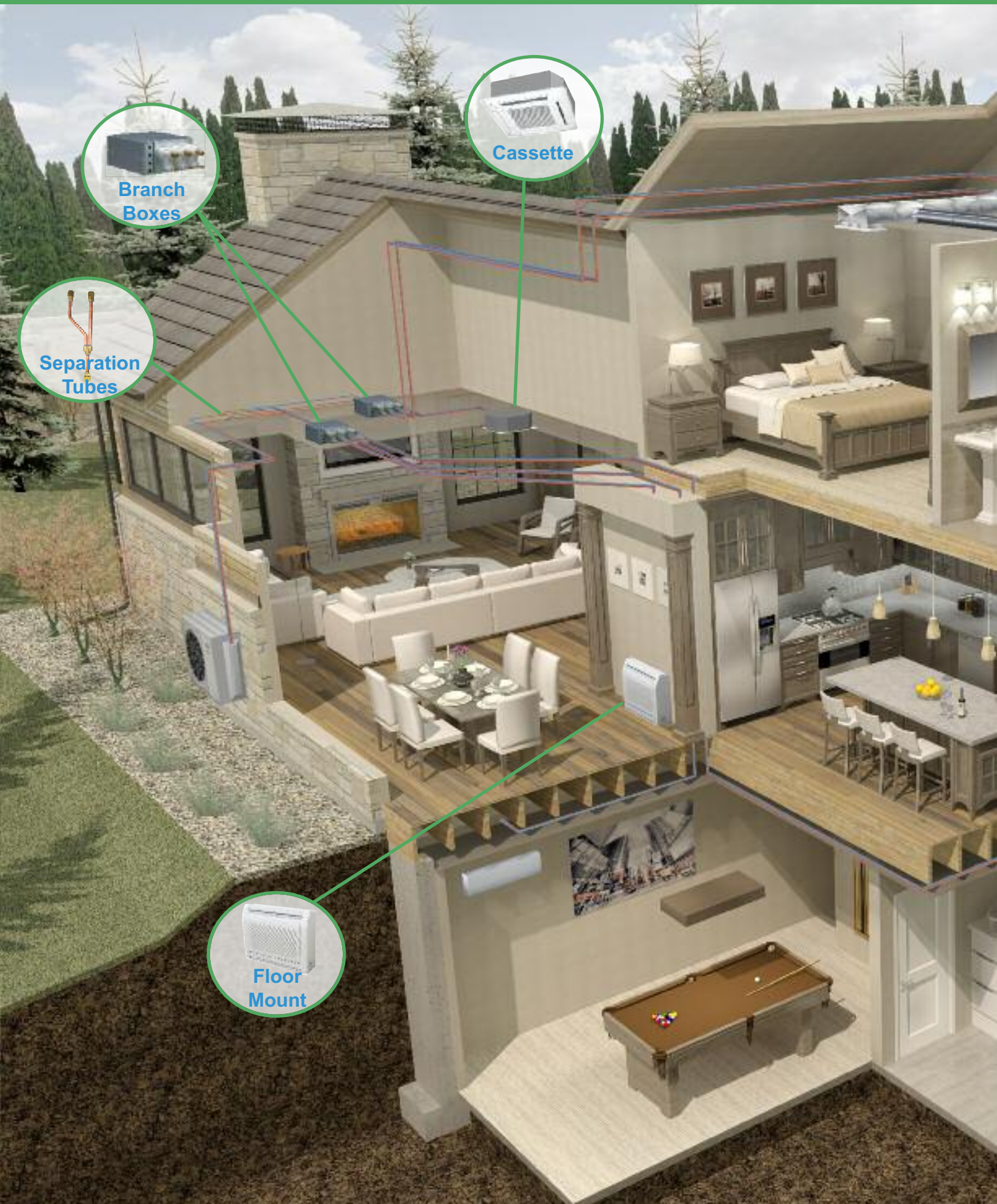

Branch Boxes



Cassette



Separation Tubes



Floor Mount



Slim Duct



Wall Mount



- Connect 2 to 8 indoor units
- 80 to 130% connectable capacity
- Connect 39,000 to 62,000 BTU
- Branch boxes and separation tubes required

Cool or heat one room, a few rooms or an entire home.

Allowable Combinations for AOU18RLXFZ, AOU18RLXFZH,

AOU24RLXFZ, AOU24RLXFZH, AOU36RLXFZ1, AOU36RLXFZH, AOU45RLXFZ



ASU7RLF1, ASU9RLF1,
ASU12RLF1, ASU15RLS2*,
ASU18RLF, ASU24RLF



ARU7RLF
ARU9RLF
ARU12RLF
ARU18RLF
ARU24RLF



AUU7RLF
AUU9RLF
AUU12RLF
AUU18RLF



AGU9RLF
AGU12RLF
AGU15RLF



AOU18RLXFZ
AOU18RLXFZH
AOU24RLXFZ
AOU24RLXFZH
AOU36RLXFZ1
AOU36RLXFZH
AOU45RLXFZ

BTU Capacity	7,000	9,000	12,000	15,000	18,000	24,000
--------------	-------	-------	--------	--------	--------	--------

AOU18RLXFZ / AOU18RLXFZH

2 INDOOR UNITS	7 7	14
	7 9	16
	7 12	19
	9 9	18
	9 12	21

AOU36RLXFZ1 / AOU36RLXFZH

2 INDOOR UNITS	12 12 15	38
	7 7 7 7	28
	7 7 7 9	30
	7 7 7 12	33
	7 7 7 15	35
	7 7 7 18**	39

3 INDOOR UNITS

	12 15 15	40
	12 15 18	44
	12 15 24	50
	12 18 18	48
	12 18 24	54
	15 15 15	42
	15 15 18	46
	15 15 24	52
	15 18 18	50
	18 18 18	54

4 INDOOR UNITS

	7 12 15 18	51
	7 15 15 15	49
	9 9 9 9	36
	9 9 9 12	39
	9 9 9 15	41
	9 9 9 18	45
	9 9 9 24	51
	9 9 12 12	42
	9 9 12 15	44
	9 9 12 18	48
	9 9 12 24	54
	9 9 15 15	46
	9 9 15 18	50
	9 9 18 18	54

AOU24RLXFZ / AOU24RLXFZH

3 INDOOR UNITS	7 7 -	14
	7 9 -	16
	7 12 -	19
	7 15	21
	7 18	25
	9 9 -	18
	9 12	21
	9 15	23
	9 18	27
	12 12	24
	12 15	26

4 INDOOR UNITS

	7 7 7 9 9	32
	7 7 7 12	35
	7 7 7 15	37
	7 7 12 12	38
	7 9 9 9	34
	7 9 9 12	37
	9 9 9 9	36

3 INDOOR UNITS

	7 7 7 15	35
	7 7 7 18	39
	7 7 7 24	45
	7 7 9 12	35
	7 7 9 15	37
	7 7 9 18	41
	7 7 9 24	47
	7 7 12 12	38
	7 7 12 15	40
	7 7 12 18	44
	7 7 12 24	50
	7 7 15 15	42
	7 7 15 18	46
	7 7 15 24	52
	7 7 18 18	50
	7 9 9 9	34
	7 9 9 12	37
	7 9 9 15	39
	7 9 9 18	43
	7 9 9 24	49
	7 9 12 12	40
	7 9 12 15	42
	7 9 12 18	46
	7 9 12 24	52
	7 9 15 15	44
	7 9 15 18	48
	7 9 18 18	52
	7 12 12 12	43
	7 12 12 15	45
	7 12 12 18	49
	7 12 12 24	55
	7 12 15 15	47

4 INDOOR UNITS

	9 9 12 24	54
	9 9 15 15	46
	9 9 15 18	50
	9 9 18 18	54
	9 12 12 12	45
	9 12 12 15	47
	9 12 12 18	51
	9 12 15 15	49
	9 12 15 18	53
	12 12 12 12	48
	12 12 12 15	50
	12 12 12 18	54
	12 12 15 15	52

3 INDOOR UNITS

	7 7 7	21
	7 7 9	23
	7 7 12	26
	7 9 9	25
	9 9 9	27

2 INDOOR UNITS

	18 18	36
	18 24	42
	24 24	48

3 INDOOR UNITS

	7 7 24	38
	7 9 18	34
	7 9 24	40
	7 12 18	37
	7 12 24	43
	7 15 15	35
	7 15 18	39
	7 15 24	45
	7 18 18	43
	7 18 24	49

4 INDOOR UNITS

	9 12 12 12	45
	9 12 12 15	47
	9 12 12 18	51
	9 12 15 15	49
	9 12 15 18	53
	12 12 12 12	48
	12 12 12 15	50
	12 12 12 18	54
	12 12 15 15	52

4 INDOOR UNITS

	7 7 7	21
	7 7 9	23
	7 7 12	26
	7 9 9	25
	9 9 9	27

3 INDOOR UNITS

	7 7 24	38
	7 9 18	34
	7 9 24	40
	7 12 18	37
	7 12 24	43
	7 15 15	35
	7 15 18	39
	7 15 24	45
	7 18 18	43
	7 18 24	49

4 INDOOR UNITS

	7 7 12 12	38
	7 7 12 15	40
	7 7 12 18	44
	7 7 12 24	50
	7 7 15 15	42
	7 7 15 18	46
	7 7 15 24	52
	7 7 18 18	50
	7 9 9 9	34
	7 9 9 12	37
	7 9 9 15	39
	7 9 9 18	43
	7 9 9 24	49
	7 9 12 12	40
	7 9 12 15	42
	7 9 12 18	46
	7 9 12 24	52
	7 9 15 15	44
	7 9 15 18	48
	7 9 18 18	52
	7 12 12 12	43
	7 12 12 15	45
	7 12 12 18	49
	7 12 12 24	55
	7 12 15 15	47

5 INDOOR UNITS

	7 7 7 7 7	35
	7 7 7 7 9	37
	7 7 7 7 12	40
	7 7 7 7 15	42
	7 7 7 7 18	46
	7 7 7 7 24	52
	7 7 7 9 9	39
	7 7 7 9 12	42
	7 7 7 9 15	44
	7 7 7 9 18	48
	7 7 7 9 24	54
	7 7 7 12 12	45
	7 7 7 12 15	47
	7 7 7 12 18	51
	7 7 7 12 24	57
	7 7 7 15 15	49
	7 7 7 15 18	53
	7 7 9 9 9	41
	7 7 9 9 12	44

4 INDOOR UNITS

	18 18	36
	7 7 15 -	28
	7 7 18 -	32
	7 7 24	38
	7 9 12 -	28
	7 9 15 -	30
	7 9 18	34
	7 12 12 -	31
	7 12 15	33
	7 12 18	37
	9 9 9 -	27
	9 9 12 -	30
	9 9 15	32
	9 9 18	36
	9 12 12	33
	9 12 15	35
	9 12 18	39
	12 12 12	36

3 INDOOR UNITS

	7 7 24	38
	7 9 18	34
	7 9 24	40
	7 12 18	37
	7 12 24	43
	7 15 15	35
	7 15 18	39
	7 15 24	45
	7 18 18	43
	7 18 24	49

4 INDOOR UNITS

	9 9 18	36
	9 9 24	42
	9 12 15	35
	9 12 18	39
	9 12 24	45
	9 15 15	37
	9 15 18	41
	9 15 24	47
	9 18 18	45
	9 18 24	51
	12 12 12	36
	12 12 15	38
	12 12 18	42
	12 12 24	47

5 INDOOR UNITS

	7 7 7 7 7	35
	7 7 7 7 9	37
	7 7 7 7 12	40
	7 7 7 7 15	42
	7 7 7 7 18	46
	7 7 7 7 24	52
	7 7 7 9 9	39
	7 7 7 9 12	42
	7 7 7 9 15	44
	7 7 7 9 18	48
	7 7 7 9 24	54
	7 7 7 12 12	45
	7 7 7 12 15	47
	7 7 7 12 18	51
	7 7 7 12 24	57
	7 7 7 15 15	49
	7 7 7 15 18	53
	7 7 9 9 9	41
	7 7 9 9 12	44

+ASU15RLS2 is NOT compatible with AOU18/24/36RLXFZH, AOU36RLXFZ1 or AOU45RLXFZ. Actual rated cooling capacity of ASU15RLS2 is 14,000 BTU/h. * The optional kit "K9FZ1818 (UTP-MU36A2)" is necessary for dual zone system "18+18". **Wall mounted type ASU18RLF can not be connected in this combination. "-" represents available circuit for future expansion when connecting this combination.

Allowable Combinations for AOU48RLXFZ1



ASU7RLF1, ASU9RLF1,
ASU12RLF1, ASU15RLS2*,
ASU18RLF, ASU24RLF



ARU7RLF
ARU9RLF
ARU12RLF
ARU18RLF
ARU24RLF



AUU7RLF
AUU9RLF
AUU12RLF
AUU18RLF



AGU9RLF
AGU12RLF
AGU15RLF



AOU48RLXFZ1

■ = Allowed "Connectable Capacity" combinations between 100 and 130%

5 INDOOR UNITS

7 7 9 9 15	46
7 7 9 9 18	50
7 7 9 12 12	47
7 7 9 12 15	49
7 7 9 12 18	53
7 7 9 15 15	51
7 7 12 12 12	50
7 7 12 12 15	52
7 9 9 9 9	43
7 9 9 9 12	46
7 9 9 9 15	48
7 9 9 9 18	52
7 9 9 12 12	49
7 9 9 12 15	51
7 9 12 12 12	52
9 9 9 9 9	45
9 9 9 9 12	48
9 9 9 9 15	50
9 9 9 9 18	54
9 9 9 12 12	51
9 9 9 12 15	53
9 9 12 12 12	54

3 INDOOR UNITS

12 12 24	48
12 15 15	40
12 15 18	44
12 15 24	50
12 18 18	48
12 18 24	54
12 24 24	60
15 15 15	42
15 15 18	46
15 15 24	52
15 18 18	50
15 18 24	56
15 24 24	62
18 18 18	54
18 18 24	60

4 INDOOR UNITS

7 12 12 15	45
7 12 12 18	49
7 12 12 24	55
7 12 15 15	47
7 12 15 18	51
7 12 15 24	57
7 12 18 18	55
7 12 18 24	61
7 15 15 15	49
7 15 15 18	53
7 15 15 24	59
7 15 18 18	57
7 18 18 18	61
9 9 9 12	39
9 9 9 15	41
9 9 9 18	45
9 9 9 24	51
9 9 12 12	42
9 9 12 15	44
9 9 12 18	48
9 9 12 24	54
9 9 15 15	46
9 9 15 18	50
9 9 15 24	56
9 9 18 18	54
9 9 18 24	60

4 INDOOR UNITS

12 12 12 24	60
12 12 15 15	52
12 12 15 18	56
12 12 15 24	62
12 12 18 18	60
12 15 15 15	54
12 15 15 18	58
12 15 18 18	62
15 15 15 15	56
15 15 15 18	60

5 INDOOR UNITS

7 7 7 7 12	40
7 7 7 7 15	42
7 7 7 7 18	46
7 7 7 7 24	52
7 7 7 9 9	39
7 7 7 9 12	42
7 7 7 9 15	44
7 7 7 9 18	48
7 7 7 9 24	54
7 7 7 12 12	45
7 7 7 12 15	47
7 7 7 12 18	51
7 7 7 12 24	57
7 7 7 15 15	49
7 7 7 15 18	53
7 7 7 15 24	59
7 7 7 18 18	57

AOU48RLXFZ1

2 INDOOR UNITS

18 24	42
24 24	48

3 INDOOR UNITS

7 9 24	40
7 12 24	43
7 15 18	40
7 15 24	46
7 18 18	43
7 18 24	49
7 24 24	55
9 9 24	42
9 12 18	39
9 12 24	45
9 15 18	42
9 15 24	48
9 18 18	45
9 18 24	51
9 24 24	57
12 12 18	42

4 INDOOR UNITS

7 7 7 18	39
7 7 7 24	45
7 7 9 18	41
7 7 9 24	47
7 7 12 15	40
7 7 12 18	44
7 7 12 24	50
7 7 15 15	42
7 7 15 18	46
7 7 15 24	52
7 7 18 18	50
7 7 18 24	56
7 7 24 24	62
7 9 9 15	39
7 9 9 18	43
7 9 9 24	49
7 9 12 12	40
7 9 12 15	42
7 9 12 18	46
7 9 12 24	52
7 9 15 15	44
7 9 15 18	48
7 9 15 24	54
7 9 18 18	52
7 9 18 24	58
7 12 12 12	43

4 INDOOR UNITS

7 12 12 15	45
7 12 12 18	49
7 12 12 24	55
7 12 15 15	47
7 12 15 18	51
7 12 15 24	57
7 12 18 18	55
7 12 18 24	61
7 15 15 15	49
7 15 15 18	53
7 15 15 24	59
7 15 18 18	57
7 18 18 18	61
9 9 9 12	39
9 9 9 15	41
9 9 9 18	45
9 9 9 24	51
9 9 12 12	42
9 9 12 15	44
9 9 12 18	48
9 9 12 24	54
9 9 15 15	46
9 9 15 18	50
9 9 15 24	56
9 9 18 18	54
9 9 18 24	60
9 12 12 12	45
9 12 12 15	47
9 12 12 18	51
9 12 12 24	57
9 12 15 15	49
9 12 15 18	53
9 12 15 24	59
9 12 18 18	57
9 15 15 15	51
9 15 15 18	55
9 15 15 24	61
9 15 18 18	59
12 12 12 12	48
12 12 12 15	50
12 12 12 18	54

5 INDOOR UNITS

7 7 7 9 9	41
7 7 7 9 12	44
7 7 7 9 15	46
7 7 7 9 18	50
7 7 7 9 24	56
7 7 7 12 12	47
7 7 7 12 15	49
7 7 7 12 18	53
7 7 7 12 24	59
7 7 7 15 15	51
7 7 7 15 18	55
7 7 7 15 24	61
7 7 7 18 18	59
7 7 12 12 12	50

Allowable Combinations for AOU48RLXFZ1



ASU7RLF1, ASU9RLF1,
ASU12RLF1, ASU15RLS2*,
ASU18RLF, ASU24RLF



ARU7RLF
ARU9RLF
ARU12RLF
ARU18RLF
ARU24RLF



AAU7RLF
AAU9RLF
AAU12RLF
AAU18RLF



AGU9RLF
AGU12RLF
AGU15RLF



AOU48RLXFZ1

BTU Capacity	7,000	9,000	12,000	15,000	18,000	24,000
= Allowed "Connectable Capacity" combinations between 100 and 130%						

5 INDOOR UNITS	7 7 12 12 15	52	5 INDOOR UNITS	9 9 12 12 12	54	6 INDOOR UNITS	7 7 9 9 9 12	53	7	7 7 9 9 9 9 12	62
	7 7 12 12 18	56		9 9 12 12 15	56		7 7 9 9 9 15	55		7 9 9 9 9 9 9	61
	7 7 12 12 24	62		9 9 12 12 18	60		7 7 9 9 9 18	59		7 7 7 7 7 7 7 7	56
	7 7 12 15 15	54		9 9 12 15 15	58		7 7 9 9 12 12	56		7 7 7 7 7 7 7 9	58
	7 7 12 15 18	58		9 9 12 15 18	62		7 7 9 9 12 15	58		7 7 7 7 7 7 7 12	61
	7 7 12 18 18	62		9 9 15 15 15	60		7 7 9 9 15 15	62		7 7 7 7 7 7 9 9	60
	7 7 15 15 15	56		9 12 12 12 12	57		9 12 12 15 15	60		7 7 9 12 12 12	59
	7 7 15 15 18	60		9 12 12 12 15	59		12 12 12 15 15	60		7 7 9 12 12 15	61
	7 9 9 9 9	43		9 12 12 15 15	61		12 12 12 12 12	60	7 7 12 12 12 12	62	
	7 9 9 9 12	46		12 12 12 15 15	62		12 12 12 12 15	62	7 9 9 9 9 9 9	52	
	7 9 9 9 15	48		7 7 7 7 7 7	42		7 7 7 7 7 7 9	44	7 9 9 9 9 12	55	
	7 9 9 9 18	52		7 7 7 7 7 12	47		7 7 7 7 7 15	49	7 9 9 9 9 15	57	
	7 9 9 9 24	58		7 7 7 7 7 15	49		7 7 7 7 7 18	53	7 9 9 9 9 18	61	
	7 9 9 12 12	49		7 7 7 7 7 18	53		7 7 7 7 7 24	59	7 9 9 9 12 12	58	
	7 9 9 12 15	51		7 7 7 7 9 9	46		7 7 7 7 9 12	49	7 9 9 9 12 15	60	
7 9 9 12 18	55	7 7 7 7 9 15	51	7 7 7 7 9 18	55	7 9 9 9 12 12	61				
7 9 9 12 24	61	7 7 7 7 9 18	55	7 7 7 7 9 24	61	9 9 9 9 9 9 9	54				
7 9 9 15 15	53	7 7 7 7 12 12	52	7 7 7 7 12 15	54	9 9 9 9 9 12	57				
7 9 9 15 18	57	7 7 7 7 12 15	54	7 7 7 7 12 18	58	9 9 9 9 9 15	59				
7 9 9 18 18	61	7 7 7 7 12 18	58	7 7 7 7 15 15	56	9 9 9 9 12 12	60				
7 9 12 12 12	52	7 7 7 7 15 18	60	7 7 7 7 15 18	60	9 9 9 9 12 15	62				
7 9 12 12 15	54	7 7 7 9 9 9	48	7 7 7 9 9 9	48	7 7 7 7 7 7 7 7	49				
7 9 12 12 18	58	7 7 7 9 9 12	51	7 7 7 9 9 12	51	7 7 7 7 7 7 7 9	51				
7 9 12 15 15	56	7 7 7 9 9 15	53	7 7 7 9 9 15	53	7 7 7 7 7 7 7 12	54				
7 9 12 15 18	60	7 7 7 9 9 18	57	7 7 7 9 9 18	57	7 7 7 7 7 7 7 15	56				
7 9 15 15 15	58	7 7 7 9 12 12	54	7 7 7 9 12 12	54	7 7 7 7 7 7 7 18	60				
7 9 15 15 18	62	7 7 7 9 12 15	56	7 7 7 9 12 15	56	7 7 7 7 7 7 9 9	53				
7 12 12 12 12	55	7 7 7 9 15 15	58	7 7 7 9 15 15	58	7 7 7 7 7 7 9 12	56				
7 12 12 12 15	57	7 7 7 9 15 18	62	7 7 7 9 15 18	62	7 7 7 7 7 7 9 15	58				
7 12 12 12 18	61	7 7 7 9 12 12	57	7 7 7 9 12 12	57	7 7 7 7 7 7 9 18	62				
7 12 12 15 15	59	7 7 7 9 12 15	61	7 7 7 9 12 15	61	7 7 7 7 7 7 9 18	62				
7 12 15 15 15	61	7 7 7 9 12 18	60	7 7 7 9 12 18	60	7 7 7 7 7 7 9 12	59				
9 9 9 9 9	45	7 7 7 9 15 15	58	7 7 7 9 15 15	58	7 7 7 7 7 7 12 15	61				
9 9 9 9 12	48	7 7 7 9 15 18	62	7 7 7 9 15 18	62	7 7 7 7 7 9 9 9	55				
9 9 9 9 15	50	7 7 7 9 12 12	54	7 7 7 9 12 12	54	7 7 7 7 7 9 9 12	58				
9 9 9 9 18	54	7 7 7 9 12 15	56	7 7 7 9 12 15	56	7 7 7 7 7 9 9 15	60				
9 9 9 9 24	60	7 7 7 9 12 18	60	7 7 7 9 12 18	60	7 7 7 7 7 9 12 12	61				
9 9 9 12 12	51	7 7 7 9 15 15	58	7 7 7 9 15 15	58	7 7 7 7 7 9 9 9	57				
9 9 9 12 15	53	7 7 7 9 15 18	62	7 7 7 9 15 18	62	7 7 7 7 7 9 9 12	58				
9 9 9 12 18	57	7 7 7 12 12 12	57	7 7 7 12 12 12	57	7 7 7 7 7 9 9 15	60				
9 9 9 15 15	55	7 7 7 12 12 15	59	7 7 7 12 12 15	59	7 7 7 7 7 9 9 18	62				
9 9 9 15 18	59	7 7 7 12 15 15	61	7 7 7 12 15 15	61	7 7 7 9 9 9 9 9	57				
		7 7 7 12 15 15	61	7 7 7 12 15 15	61	7 7 7 9 9 9 9 12	60				
		7 7 9 9 9 9	50	7 7 9 9 9 9	50	7 7 7 9 9 9 9 15	62				
						7 7 7 9 9 9 9 18	62				
						7 7 9 9 9 9 9 9	59				

*ASU15RLS2 is NOT compatible with AOU18/24/36RLXFZH, AOU36RLXFZ1 or AOU45RLXFZ. Actual rated cooling capacity of ASU15RLS2 is 14,000 BTU/h.

Remote Controls

Wired Remote Controller*

UTY-RNBYU[^]/UTY-RNNUM[^]

Group Control

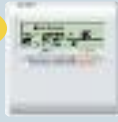

The wired remote controller with its unique lock function and sleek design provides full feature access to property managers, building owners, and facility maintenance, as well as providing basic comfort features to tenants, employees, and teachers.

Wired Remote Controller

UTY-RVNUM

Group Control



Features a large backlit LCD display and displays the room temperature. Provides full feature access to property managers, building owners, and facility maintenance, as well as providing basic comfort features to tenants, employees, and teachers.

Simple Remote Controller

UTY-RSNUM*

Group Control



Suitable when only basic operations are required for hotels, offices and other places where there is frequent arrival and departure of occupants. Features a backlit display. Remote does not allow any timer settings.

Wireless Remote Controller

UTY-LNHUM



For spaces where there is just no place to mount the wired remote or where wireless operation is preferred.

Central Remote Controller

UTY-DMMUM



This remote controls up to 8 individual indoor units. Set temperatures on timers to best meet individuals' needs. Includes a large backlit LCD and 4-way navigation pad. Remote connects in daisy chain to branch boxes.

Wired Remote (Touch Panel)

UTY-RNRUZ1



Features a large backlit LCD display and displays the room temperature. Provides full feature access to property managers, building owners, and facility maintenance, as well as providing basic comfort features to tenants, employees, and teachers. *Compatible with System 30RLXEH only.*

Remote Sensor

UTY-XSZX



Wall mounted room temperature sensor for slim duct models. Replaces room temperature sensor in the return when installed while still allowing for temperature correction.

Receiver Unit

UTY-LRHUM



For slim duct models. Includes a wireless remote control.

Group Control: With this feature, multiple evaporators can be 'daisy-chained' together on one single remote controller, allowing for multiple single-zoned systems installed in an application to be grouped together by evaporator. The same feature can be used on a multi-zone system however, multiple multi-zone systems cannot be grouped together nor can a single-zone system be group controlled with a multi-zone system. For additional information, see Engineering Bulletin # 036 and/or 037.

Wi-Fi Devices

IR Wireless Module

Model: FJ-IR-WIFI-1NA

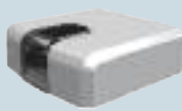

Wired Module

Model: FJ-RC-WIFI-1NA



Plug Model

UTY-WIFI

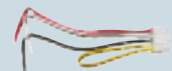

In order to connect certain models to Wired Wi-Fi Module, FJ-RC-WIFI-1NA, this plug must be used.

Remotely manage mini-split systems using a simple smartphone, tablet, or PC via the Internet. The mini-splits are controlled from a webpage or using an iOS or Android APP in a very intuitive way. A wireless (Wi-Fi) device installed in each unit controls the operation. A Server in the cloud manages the whole process.











Features of Wi-Fi Devices

- Turn the mini-split on before arriving home.
- Change the program if the user is arriving late.
- Know the current room temperature of your home.
- Check if the unit is still on once out of your home and turn it off.
- Program the mini-split with a calendar scheduler in an easy, intuitive way.
- Available in several languages. (Also °C and °F)
- Save money without losing comfort.
- Get instant alarm notifications.

[^] Minimum Heat, Sleep Timer functions will be lost when the wired remote controller is installed.

* Wall mounted ASU7, 9, and 12RLF1 require accessory interface kit (Part UTY-XCBXZ2) in order to connect this device to them. Wall mounted ASU9, 12, and 15RLS3/H require accessory interface kit (Part UTY-TWBXF1) in order to connect this device to them.

Interface Kits

<p>Dry Contact Wire Kit* UTY-XWZX/UTY-XWZXZ5</p>  <p>Turns system on or off using a normally open circuit. For example in home automation, BMS integration of only On/Off operation, occupancy sensor, key card switch, or lead-lag control of other heating/cooling devices.</p>	<p>Interface Kit UTY-XCBXZ2</p>  <p>Required to connect ASU7RLF1, 9RLF1, and 12RLF1 to Wired Remotes UTY-RNNUM and UTY-RVNUM, Dry Contact Wire Kit UTY-XWZX, and Simple Remote Control UTY-RSNUM.</p>	<p>Interface Kit UTY-TWBXF1</p>  <p>Required to connect the ASU15RLS2/H* and ASU9, 12, 15RLS3/H to Wired Remotes UTY-RNNUM and UTY-RVNUM, Dry Contact Wire Kit UTY-XWZXZ5, and Simple Remote Control UTY-RSNUM.</p>	
<p>Slim Duct Connector Kit UTD-ECS5A</p>  <p>Comes with 5 sets of wires. Can be used to turn unit on/off, wire in float switch, AUX heater, turn on an external device (Fan), or show if the unit is running.</p>	<p>Outdoor Unit Input/Output Connector UTY-XWZXZ3</p>  <p>Gives the ability to limit the noise of the unit*, stop the outdoor unit, limit power consumption*, control the operating mode (Htg/Clg), or use output status to see if the compressor is running. You will need to order a kit for each option.</p> <p><small>*Will reduce capacity.</small></p>	<p>Outdoor Unit Base Heater Connector UTY-XWZXZ4</p>  <p>Used to hook up an AUX base pan heater to the outdoor unit. Heater will stop ice from forming in the outdoor unit. Base heater will operate when outdoor temperature is below 36°F. Heater is field supply. Heaters greater than 25W can't be fed directly from the board, but have to be powered from another source.</p>	
<p>Interface Kit UTY-XCSXZ1</p>  <p>Required to connect ASU30RLE to Wired Touch Panel Remote UTY-RNRUZ1, Wired Remote UTY-RVNUM, Wired Remote UTY-RNNUM, Simple Remote UTY-RSNUM, Dry Contact Wire Kit UTY-XWZX, and Lead Lag Control function^.</p>		<p>Interface Kit Box UTZ-GXXB</p>  <p>Used to conceal Interface Kit UTY-XCSXZ1.</p>	<p>^ Wired remotes cannot be used when using this feature. This includes UTY-RNRUZ1, UTY-RVNUM, UTY-RNNUM, UTY-RSNUM.</p>

Fresh Air Intake Kits

<p>High Humidity Insulation Kit UTZ-KXGC</p>  <p>Additional insulation for compact cassette units, which may be needed when they are installed in high humidity areas.</p>	<p>Air Outlet Shutter Plate UTR-YDZB</p>  <p>In a 3-way air flow configuration an Air Outlet Shutter Plate kit is required to block air flow of 1 louver.</p>	<p>Fresh Air Intake Kit UTZ-VXAA</p>  <p>Mixes room air then passes it through a heat exchanger. Allows for a 4-inch flex duct connection. Requires a field supplied duct booster fan capable of 60 CFM at .2"W.C. or 90 CFM at .4"W.C. For fan static pressure requirements, see installation manual.</p>	<p>Fresh Air Intake Kit KHRS940-25</p>  <p>Kit contains current sensor with built-in relay (Split Core Fixed Threshold Current Status Sensor with Command Relay) and Switching Power Supply. Duct and Fan are field supply. A fan capable of generating 15 CFM at a static pressure of approximately .26 inches W.C. required.</p>
--	---	---	--

Miscellaneous

<p>3-Pole Single Throw Safety Switch K3PST</p>  <p>For use where code requires a disconnect at the indoor unit.</p>	<p>R410A Swivel Adapter K9R410A55</p>  <p>In order to minimize incorrect charging of systems with R22 Fujitsu uses a different access port. Contractors will need this 55-degree swivel access fitting.</p>	
<p>Condensate Pump UTR-DPB24T</p>  <p>OEM design plugs into factory harness for ease of installation. Rated for 11.8" of vertical lift. Only used with System 36RSLX.</p>	<p>18+18 Combo Fittings Kit K9FZ1818 <i>(For AOU36RLXFZ1 only)</i></p>  <p>Allows two 18,000 BTU indoor units to be used. Requires special piping; limited to only 18,000 BTU models. Total BTU capacity is limited to 31,600 BTU in cooling. The kit upsizes linesets to 3/8" and 1/2".</p>	<p>Auto Louver Grille Kit* UTD-GXSA-W (for ARU7/9/12) UTD-GXSB-W (for ARU18) UTD-GXSC-W (for ARU24)</p>  <p>Auto Louver provides comfortable airflow and blends in with various interiors. Grille can be connected either directly to indoor unit or through the rectangular duct.</p>

* Only compatible with ARU models with serial numbers greater than 2000.

Things To Know Before You Buy a Fujitsu System

Complete System Warranty

Standard warranties vary depending on model:

- 2 Year Parts, 6 Year Compressor Warranty OR
- 5 Year Parts, 7 Year Compressor Warranty.



Extended warranties include:

- 10 Year Parts/Compressor Warranty for Halcyon systems that have been installed by a licensed contractor and the online Product Registration* has been submitted.
- 12 Year Parts/Compressor Warranty for Halcyon systems that have been installed by an Elite Contractor and the online Product Registration* has been submitted.



10-Year and 12-Year Warranties exclude: R22 models, IAQ models, ASU30RLX, ABU18RULX, ABU24RULX, ABU36RSLX, AUU18RLCX, AUU24RCLX, AUU36RCLX, AUU42RCLX, AOU18RLX, AOU24RLX, AOU30RLX, AOU36RLX, AOU42RLX

* Residents of California and Quebec are not required to register the System in order to obtain all of the rights and remedies applicable to this Warranty.

For full details, see Halcyon Warranty Statement.

Trademarks

The Fujitsu logo is a registered trademark of Fujitsu Limited. The Halcyon and Halcyon HFI logos and names are trademarks of Fujitsu General America, Inc. ENERGY STAR® is a registered trademark of the EPA and DOE. Copyright © 2016 Fujitsu General America, Inc.

Non-Internet Retail Policy

Internet sales are strictly prohibited and unauthorized. Any HVAC systems purchased on the Internet, from an online retailer or any similar e-tailing website, OR where the original factory serial numbers of the display have been removed, defaced, or replaced in any way WILL NOT BE COVERED BY WARRANTY.

Note: Condensing units come pre-charged from factory. Additional refrigerant may be required, be sure to check installation manual for more details.

- Cooling capacity is based on the following conditions:
 - Indoor temperature: 80°F DB/67°F WB (26.7°C DB/19.4°C WB)
 - Outdoor temperature: 95°F DB/75°F WB (35°C DB/23.9°C WB)
- Heating capacity is based on the following conditions:
 - Indoor temperature: 70°F DB (21.1°C DB)
 - Outdoor temperature: 47°F DB/43°F WB (8.3°C DB/6.1°C WB)

Things To Know Before You Install a Fujitsu System

Warning

Always use a licensed installer or contractor to install this product. Do not try to install the product yourself. Improper installation can result in water or refrigerant leakage, electrical shock, fire or explosion. Use only parts and accessories supplied or specified by Fujitsu. Ask a licensed contractor to install parts and accessories. Use of unauthorized or improper installation of parts and accessories can result in injury or property damage. Read the owner's operation manual carefully before using this product. The owners operation manual provides important safety instructions and warnings which should be followed closely. For any questions or concerns, please contact Fujitsu General America, Inc. Proper sizing and installation of equipment is critical to achieve optimal performance. Split system air conditioners and heat pumps must be matched with appropriate coil components to meet ENERGY STAR criteria. Ask your contractor for details or visit www.energystar.gov.

Heat Pump Disclaimer

In most climates a heat pump will handle all of your heating needs. However, this system sometimes requires some other additional source of heat to satisfy heating requirements in the coldest environments. Almost all of Fujitsu's heat pumps use inverter technology and as such offer a wider operating range and more heat capacity than a standard heat pump but will not provide adequate heating if improperly sized or operated outside of its operating range. Specifications vary by model; please consult your contractor before choosing a heat pump as your only source of heat. Systems will maintain temperature up to +/-4 degrees relative to set temperature. To increase energy efficiency on multi-type systems, you should turn off the evaporators when heating or cooling is not needed.

Disclaimer

Fujitsu's products are subject to continuous improvements. Fujitsu reserves the right to modify product design, specifications and information in this brochure without notice and without incurring any obligations.

Certifications

ISO

ISO14001 is the standard defined by the International Organization for Standardization (ISO) related to environmental management systems. Fujitsu General America, Inc. has been acknowledged by an internationally accredited compliance organization as having an appropriate program of environmental protection procedures and activities to meet the requirements of ISO14001. The air conditioners manufactured by Fujitsu have received ISO9001 series certification for quality assurance.



- ISO9001
- ISO14001

ASTM

Our outdoor units shall withstand 1,000 hours of salt spray tested per procedure ASTM B117.

RoHS Compliant

Fujitsu participates in the RoHS Directive, which is the Restriction of Hazardous Substances in electrical and electronic equipment. It is an EU directive intended protect the environment by forcing manufacturers to eliminate or severely curtail the use of cadmium, hexavalent chromium, and lead in all products from automobiles to consumer electronics.



AHRI Energy Guide® Program (U.S.)

To view AHRI numbers or Energy Guide labels, please go to www.ahridirectory.org.



HRAI EnerGuide® Program (Canada)

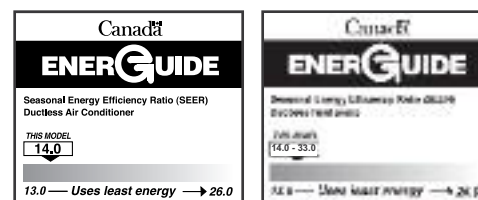

For over 40 years,
making the hottest places cool
and the coolest places...
more comfortable.

Halcyon Mini-Splits Are For You If:

- If you want to reduce your utility bills by up to 25%
- Central air quotes give you sticker shock
- You don't want to lose closet space to ductwork
- You have warm or cold spots in your home or business
- Your window air conditioner's noise prevents you from hearing the television

Halcyon 



Distributed by:

FUJITSU

Fujitsu General America, Inc.
353 Route 46 West
Fairfield, NJ 07004
Toll Free: (888) 888-3424
Local: (973) 575-0380
Fax: (973) 836-0447
Email: hvac@fujitsugeneral.com
www.fujitsugeneral.com

A subsidiary of
Fujitsu General Limited

